



General catalog
2015





Welcome to perfection,
functionality and quality.

Welcome
to König & Meyer.



1,500 products.
65 years of tradition.
One brand.

„We are a family-operated company
that takes our social and environmental
responsibility seriously, generates creative
ideas, and treats our employees, customers
and suppliers fairly.”



In the music world, we have stood for intelligent accessories of an outstanding quality and unique design since 1949. Over the decades, many developments have become standard in the music industry, such as the classic 101 music stands, the 210/2 microphone stands, but also the instrument stands for trumpets, clarinets, and flugelhorns, which can be stored in the instrument bell or the invention of the ring-lock system to firmly position speakers.

We remain a family-run company for whom social and environmental responsibility is important and we are proud of where we are based, in Wertheim, Germany. Here we have 250 employees who ensure that our products are efficiently made to high quality standards with good service and punctual delivery. From development through production to marketing, we are uncompromising in our goal of providing a premium-level service.

Above all, however, it is people who make our company what it is: our customers, our employees, and our suppliers. By working in partnership with one another and ensuring mutual respect, we have enjoyed trusted collaborations for decades. It is our ethos to build up reliable and long-term relationships with our partners and to ensure that these relationships are maintained. Thank you for remaining true to our company and our products for so many years. We are looking forward to continuing our successful collaboration in the future.

Gabriela König
CEO

Heiko Wolz
CTO

Martin König
President



TECHNOLOGY

Precision is the ultimate key to quality

Technology is our focus right from the start with the initial design of a new product. Together with our highly qualified employees we operate an independent research and development department. Processing is not the only area that requires careful planning; the qualities and functions that make our stands so outstanding also have to be well thought-out. We even make our own tools and equipment so that the new products we envision achieve the quality we are known for.

Our certified quality management system (DIN EN ISO 9001:2008) and qualified employees ensure that every single product is delivered on time in the very best quality. Innovative technology, exceptional high vertical integration and consistent re-investment in machinery provide König&Meyer with the flexibility to respond quickly and easily to customer needs.



IDEAS

Innovation as a driving force

„Our products are the result of an understanding of tradition, a demand for quality and a talent for invention.”

Driven by perfection, innovation and precision, we continually develop new products. The products of tomorrow are based on state-of-the-art computer technology, short development times and the very best quality.

Design, feel, and ergonomics – we test and assess everything to ensure it meets our uncompromising expectations from the initial design to the final product. At König & Meyer perfection is the standard. We know only a strong brand with unique service and outstanding quality will keep our customers coming back.

2013

Precision and perfection down to the smallest detail – thanks to a new flat laser cutting machine.

2010

Solar energy panels, a second tube laser cutting machine and a vertical conveyor improve process flow.

2009

Awarded the “Safety with System” seal of quality for excellent safety and health in the workplace

2007

Certification for the successful introduction of a quality management system.

2006

A new tube laser cutting machine is taken online, opening up new manufacturing potential.

2001

König & Meyer supports different bands and projects from a wide range of musical genres.

1987

The production range is expanded to include keyboard stands, mixer stands and 19” racks.

1968

Stands manufactured for other industry branches (e.g. IV stands, stands for hair-dryer hoods)

1959

An extensive range from microphone stands and boom arms to speaker stands is developed.

1951

The number of employees increases to 60. The range is expanded to include instrument and microphone stands.

1949

Company founded with ten employees who manufacture music stands and measuring instruments.



Exclusive and innovative at König & Meyer: multimedia accessories, the »Elegance« one-hand microphone stand for soundless and easy height adjustment, and the »Spider Pro« keyboard stand.

K&M KÖNIG & MEYER SPIDER PRO

MUSIC

Enjoy the pleasure of making music

Music means something different to everyone. From classic to electronic, live or solo vocals: every artist lives through the music they create. So it is important to recognize the very different needs musicians have and to be able to offer the best range of accessories.

From classical to pop, from the garage to the largest stage – across the globe musicians and artists encounter the König & Meyer product world they have come to trust – music stands, microphone and instrument stands, a wide range of other stands and holders, and much, much more.

music



PASSION

Perfection is our philosophy

„Our philosophy is to produce products of excellent quality and durability in an environmentally friendly manner so that musicians worldwide can focus on what’s most important – their music.”

Whether you are a beginner or a professional – König & Meyer offers optimal music accessories for any area of application. First-rate materials and optimized product processing result in tangible manufacturing quality right down to the smallest details. We only use precision steel tubes, which are consistent in their dimensions and tolerances. Metal and plastic parts are manufactured in-house and we have been developing and building tools and equipment ourselves for many years now. Our exceptional standards have established the König & Meyer name as an outstanding brand throughout the world.



Passion

ENVIRONMENT

Sustainable management

„Resources are too valuable to waste. Whether we are making a music stand, a microphone stand or a speaker stand, resource conservation and environmental protection are firmly anchored in every step of our production.”

We prevent waste, conserve water and energy and reduce emissions whenever possible. All environmentally relevant processes are continually reviewed and we develop strategies and measures to minimize resource consumption and environmental impact.

At König & Meyer environmental protection has been a fundamental corporate goal for decades. Our unlimited commitment to quality and the environment in the production process translates into the most effective use of raw materials, saving energy, increasing our use of renewable energies, recycling components and products at the end of their lives, avoiding pollutants in production, reducing CO₂ emissions, lowering water consumption and treating waste water from the production process, turning it back into drinking water. Since 1979 we have succeeded in reducing our water consumption by 94 percent.

König & Meyer was awarded the Environmental Prize of the Federal State of Baden-Württemberg for our outstanding achievements in promoting environmental protection and for our environment-based management.



König & Meyer has been certified according to the recognized ISO 14001 standard since 2000 and the EU EMAS Regulation since 1998.

SERVICE

A strong partnership

Along with optimal delivery capacity and products of exceptional quality, we offer our customers additional services: a 5-year warranty on our products (excludes lights, bulbs and batteries) and 10-year spare parts service for all our catalogue products. Our service range distinguishes the König&Meyer brand. We want to make it even easier for our customers to choose in favor of our music accessories.



Our idea of customer satisfaction includes offering extensive product information and quick and direct routes of communication. Visit our website for information, videos and setup instructions, and keep up the latest König & Meyer brand news on Facebook, Twitter and our YouTube channel. We welcome your feedback.



www.k-m.de/en



contact@k-m.de



www.facebook.com/KoenigundMeyer



twitter.com/koenigumeyer_en



www.youtube.com/KoenigundMeyer



Feel free to choose

When it comes to stands for speakers, guitars, or music:

König & Meyer knows what musicians want.

We develop and optimize our products according to their needs and wishes to ensure they fulfill every expectation.



BASELINE ★

Basic and/or standard products

TOPLINE ★★

Professional products for stage and studio

STARLINE ★★★

Products with extraordinary features or special designs

TÜV/GS approved



TÜV type approved



Product video via the internet (per QR code)

Using an app (small program) and your smart phone camera, you can view a video about this product. You can also enter the internet address into your web browser.



p10e.k-m.de



Music stands
14

Stands and accessories for instruments
48

Drummer's thrones, benches & stools
100

Keyboard stands
120

Stands for mixer, monitors and
19" rack-mounted products
144

Microphone stands
158

Speaker, lighting and monitor stands
206

Multimedia equipment
246

Shop fittings
266

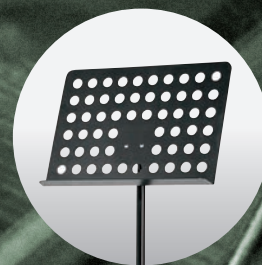



MUSIC STANDS

König & Meyer music stands are virtually unsurpassed in quality the world over. All elements of the stands' construction are precisely calibrated to ensure perfect interplay. Meticulously selected materials guarantee carefree setup and breakdown – and of course a sturdy stand – year after year.

Thanks to the variety of styles and sizes of music stands that König & Meyer has to offer, everyone – from the budding music pupil to the professional musician – can find the perfect stand for his or her individual needs.

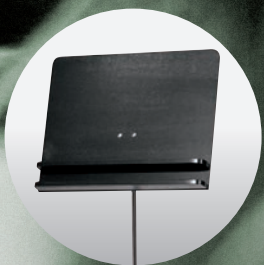

MUSIC STAND

101 BASELINE

Weight	1.04 kg
Special features	the K&M Classic
Material	steel
Leg construction	brace construction, folds compactly
Music desk	traditionally foldable
Rod combination	3-piece folding design
Size when folded	390 mm
Height	from 650 to 1,225 mm
Music desk dimensions	440 x 215 mm

Order No.

nickel-colored	10100-013-11
black	10100-013-55

Accessories

Page

Carrying case 10111	44
---------------------	----





For those who like plenty of color

MUSIC STAND

100/1	BASELINE
Weight	1.3 kg
Special features	different colors available
Material	steel
Leg construction	U-profile legs snap into socket
Music desk	traditionally foldable
Rod combination	3-piece folding design
Size when folded	490 mm
Height	from 625 to 1,240 mm
Music desk dimensions	435 x 215 mm

Order No.

blue	10010-000-54
black	10010-000-55
white	10010-000-57
red	10010-000-59
green	10010-000-60
yellow	10010-000-61
lilac	10010-000-65
silver shadow	10010-000-78
rainbow	10010-000-99

Accessories

Page

Carrying case 10012

44



MUSIC STAND

NEW

10040	BASELINE
Weight	1.3 kg
Special features	music stand can be opened and folded in one simple movement
Material	steel
Leg construction	U-profile legs snap into socket
Music desk	easy to fold
Rod combination	3-piece folding design
Size when folded	490 mm
Height	from 650 to 1,240 mm
Music desk dimensions	425 x 215 mm

Order No.

black	10040-000-55
-------	--------------

Accessories

Page

Carrying case 10012	44
---------------------	----

MUSIC STAND

100/5	BASELINE
Weight	1.5 kg
Special features	different colors available
Material	steel
Leg construction	brace construction, folds compactly
Music desk	traditionally foldable
Rod combination	3-piece folding design
Size when folded	460 mm
Height	from 500 to 1,300 mm
Music desk dimensions	435 x 215 mm

Order No.

nickel-colored	10050-000-11
blue	10050-000-54
black	10050-000-55
red	10050-000-59
silver shadow	10050-000-78
rainbow	10050-000-99

Accessories

Page

Carrying case 10012	44
---------------------	----

MUSIC STAND

NEW

10052	BASELINE
Weight	1.5 kg
Special features	extra high
Material	steel
Leg construction	brace construction, folds compactly
Music desk	traditionally foldable
Rod combination	3-piece folding design
Size when folded	580 mm
Height	from 640 to 1,500 mm
Music desk dimensions	435 x 215 mm

Order No.

black	10052-000-55
-------	--------------

Accessories

Page

Carrying case 10711	44
---------------------	----

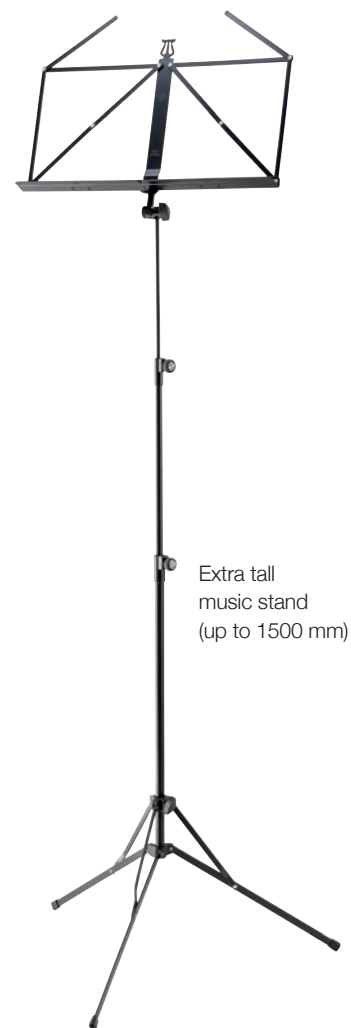

MUSIC STAND »ROBBY PLUS«

NEW

10062	TOPLINE
Weight	1.75 kg
Special features	extra-wide, extra stable expandable music desk, with additional sheet holders (775 mm)
Material	steel
Leg construction	U-profile legs with cross braces
Music desk	traditionally foldable
Rod combination	3-piece folding design
Size when folded	500 mm
Height	from 580 to 1,220 mm
Music desk dimensions	485 x 240 x 42 mm

Order No.	
black	10062-015-55

Accessories	Page
Carrying case 10012	44

MUSIC STAND

10065	TOPLINE
Weight	1.55 kg
Material	steel
Leg construction	U-profile legs with cross braces
Music desk	traditionally foldable
Rod combination	3-piece folding design
Size when folded	490 mm
Height	from 585 to 1,220 mm
Music desk dimensions	485 x 240 x 42 mm

Order No.	
nickel-colored	10065-000-11
black	10065-000-55
silver shadow	10065-000-78

Accessories	Page
Carrying case 10012	44

MUSIC STAND

107	STARLINE
Weight	2.45 kg
Special features	extremely stable
Material	steel
Leg construction	solid brace construction, folds compactly
Music desk	traditionally foldable
Rod combination	3-piece folding design
Size when folded	680 mm
Height	from 675 to 1,470 mm
Music desk dimensions	485 x 240 x 42 mm

Order No.	
nickel-colored	10700-000-11
black	10700-000-55

Accessories	Page
Carrying case 10711	44





MUSIC STAND

10810	STARLINE
Weight	2.5 kg
Special features	integrated nameplate
Material	steel
Leg construction	U-profile legs with cross braces
Music desk	traditionally foldable
Rod combination	3-piece folding design
Size when folded	680 x 90 x 120 mm
Height	from 720 to 1,520 mm
Music desk dimensions	500 x 240 mm

Order No.

black	10810-000-55
-------	--------------

The most impressive stand in its class. This extremely stable design of stand has a sheet music desk of 500 x 240 mm – for size plus grandeur. The three-piece folding music stand has easy-to-use clamping elements. Its large music desk (with integrated name plate) has plenty of room for heavy folders and is an alternative to a music stand with a plate.

Accessories

Carrying case 10811

Page

44



ORCHESTRA MUSIC STAND

NEW

11870	BASELINE
Weight	2.8 kg
Special features	user-friendly, quick-release lock
Material	aluminum stand, steel desk
Base diameter	750 mm
Leg construction	tube legs with cross braces
Rod combination	3-piece folding design
Connection stand/plate	quick-release lock
Size when folded	655 x 100 x 100 mm
Height	from 650 to 1,500 mm
Music desk dimensions	490 x 340 x 50 mm

Order No.	
black	11870-015-55

Accessories	Page
Carrying case 11450	44

MUSIC STAND

12179	BASELINE
Weight	3.02 kg
Special features	perforated music desk
Material	steel
Leg construction	U-profile legs snap into socket
Rod combination	2-piece folding design
Connection stand/plate	quick-release lock
Height	from 610 to 1,080 mm
Music desk dimensions	500 x 340 mm

Order No.	
black	12179-000-55

Accessories	Page
Carrying case 11450	44

SCHOOL ORCHESTRA MUSIC STAND

10068	TOPLINE
Weight	2.265 kg
Material	steel stand, aluminum desk
Leg construction	U-profile legs with cross braces
Rod combination	3-piece folding design
Connection stand/plate	prismatic »V-block« connector
Height	from 555 to 1,190 mm
Music desk dimensions	480 x 300 mm

Order No.	
black	10068-000-55

Accessories	Page
Carrying case 11450	44

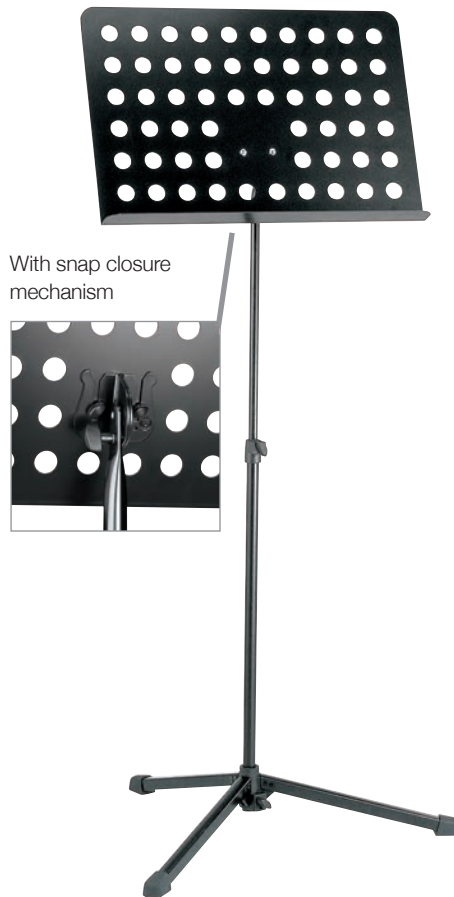



ORCHESTRA MUSIC STAND

118/1	TOPLINE
Weight	4.3 kg
Material	steel stand, aluminum or wooden desk
Leg construction	socket with foldable legs
Rod combination	2-piece folding design
Connection stand/plate	prismatic »V-block« connector
Height	from 680 to 1,210 mm
Music desk dimensions (wood)	550 x 355 mm
Music desk dimensions (Aluminum)	520 x 355 mm

Order No.

nickel stand, walnut wooden desk	11811-050-01
nickel stand, walnut wooden desk (unit: 2 pcs.)	11811-000-01
nickel stand, black wooden desk	11812-000-01
black stand, black wooden desk	11812-000-55
black stand, black aluminum desk	11818-000-55
nickel stand, beech wooden desk	11819-500-01

Accessories

	Page
Carrying case 11450	44

ORCHESTRA MUSIC STAND

118/3	TOPLINE
Weight	5 kg
Special features	additional shelf
Material	steel stand, wooden desk
Leg construction	socket with foldable legs
Rod combination	2-piece folding design
Connection stand/plate	prismatic »V-block« connector
Height	from 615 to 1,150 mm
Music desk dimensions	550 x 440 mm

Order No.

nickel stand with walnut wooden desk	11831-000-01
nickel stand with black wooden desk	11832-000-01



Prismatic »V-block« Connector



Prismatic »V-block« Connector

ORCHESTRA MUSIC STAND

118/4	TOPLINE
Weight	4.6 kg
Special features	extra high
Material	steel stand, wooden desk
Leg construction	socket with foldable legs
Rod combination	3-piece folding design
Connection stand/plate	prismatic »V-block« connector
Height	from 740 to 1,635 mm
Music desk dimensions	550 x 355 mm

Order No.

nickel stand, walnut wooden desk	11841-000-01
nickel stand, black wooden desk	11842-000-01

ORCHESTRA MUSIC STAND

118/5	TOPLINE
Weight	5.73 kg
Special features	stackable
Material	steel stand, wooden desk
Leg construction	socket with screw-in legs
Rod combination	2-piece folding design
Connection stand/plate	prismatic »V-block« connector
Height	from 785 to 1,235 mm
Music desk dimensions	550 x 355 mm

Order No.

black	11852-000-55
-------	--------------

Accessories

	Page
Carrying case 11450	44

**ORCHESTRA MUSIC STAND
»SYMPHONY«**

11865	TOPLINE
Weight	3.92 kg
Special features	unique stamping; clutch height adjustment
Material	steel
Leg construction	socket with foldable legs
Rod combination	2-piece folding design
Connection stand/plate	prismatic »V-block« connector
Height	from 790 to 1,340 mm
Music desk dimensions	480 x 340 mm

Order No.

black	11865-000-55
-------	--------------

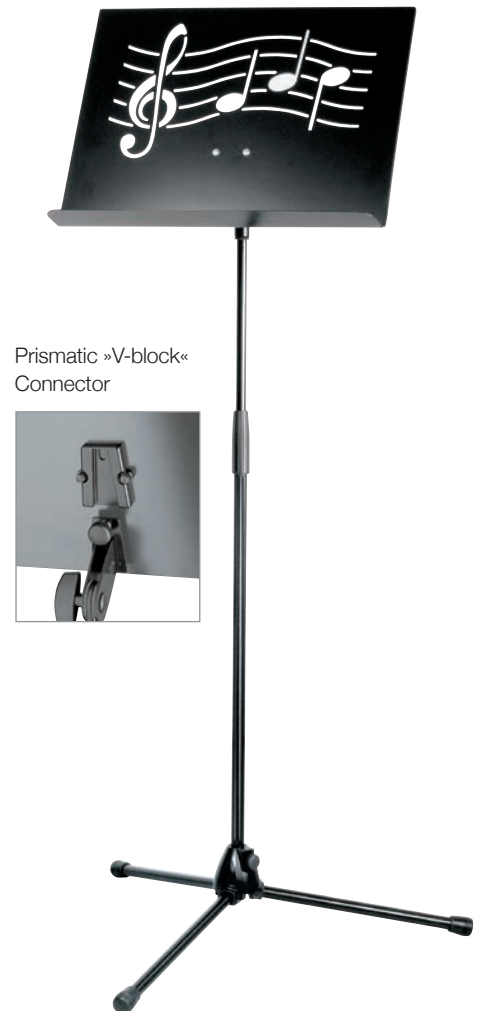



ORCHESTRA MUSIC STAND

11899	TOPLINE
Weight	4.17 kg
Special features	perforated music desk
Material	steel
Leg construction	tube legs with cross braces
Rod combination	2-piece folding design
Connection stand/plate	quick-release lock
Height	from 700 to 1,200 mm
Music desk dimensions	500 x 340 mm

Order No.

black 11899-000-55

Accessories

Page

Carrying case 11450 44

ORCHESTRA MUSIC STAND

11940	TOPLINE
Weight	3.6 kg
Special features	user-friendly, quick-release lock
Material	steel
Base diameter	750 mm
Leg construction	tube legs with cross braces
Rod combination	2-piece folding design
Connection stand/plate	quick-release lock
Size when folded	730 x 100 x 100 mm
Height	from 740 to 1,270 mm
Music desk dimensions	490 x 340 x 50 mm

Order No.

black 11940-000-55

Accessories

Page

Carrying case 11460 44

ORCHESTRA MUSIC STAND

NEW

11960	TOPLINE
Weight	3.7 kg
Special features	user-friendly, quick-release lock
Material	steel
Base diameter	750 mm
Leg construction	tube legs with cross braces
Rod combination	2-piece folding design
Connection stand/plate	quick-release lock
Size when folded	730 x 100 x 100 mm
Height	from 740 to 1,270 mm
Music desk dimensions	490 x 340 x 50 mm

Order No.

black 11960-000-55

Accessories

Page

Carrying case 11460 44



ORCHESTRA MUSIC STAND

12120	TOPLINE
Weight	2.64 kg
Special features	collapsible music desk; nylon bag is included
Material	steel stand, plastic desk
Leg construction	socket with foldable legs
Rod combination	2-piece folding design
Connection stand/plate	non-detachable
Height	from 545 to 1,220 mm
Music desk dimensions	505 x 340 mm

Order No.	
black	12120-000-55

ORCHESTRA MUSIC STAND

12125	TOPLINE
Weight	3.14 kg
Special features	extra high; collapsible music desk; nylon bag is included
Material	steel stand, plastic desk
Leg construction	socket with foldable legs
Rod combination	3-piece folding design
Connection stand/plate	non-detachable
Height	from 720 to 1,550 mm
Music desk dimensions	505 x 340 mm

Order No.	
black	12125-000-55

ORCHESTRA MUSIC STAND

11888	STARLINE
Weight	3.06 kg
Material	aluminum
Leg construction	tube legs with cross braces
Rod combination	2-piece folding design
Connection stand/plate	prismatic »V-block« connector
Height	from 710 to 1,215 mm
Music desk dimensions	520 x 360 mm

Order No.	
black	11888-050-55
black (unit: 2 pcs.)	11888-000-55

Accessories	Page
Carrying case 11450	44

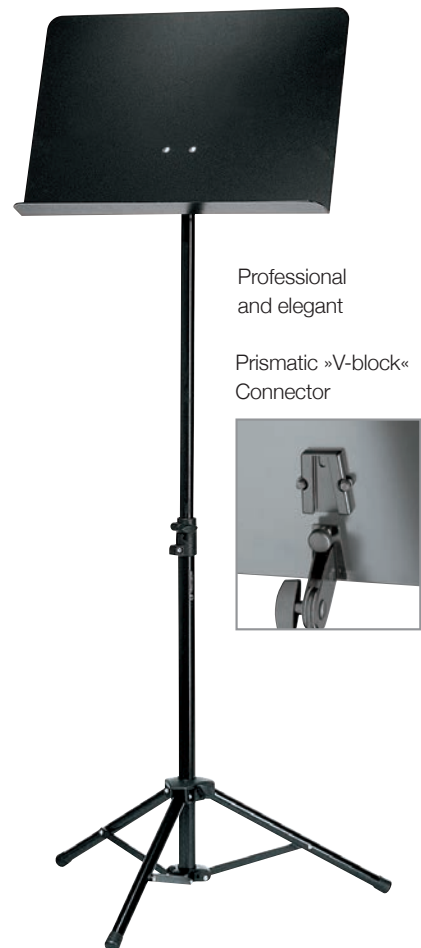

ONE-HAND ORCHESTRA MUSIC STAND

11950	STARLINE
Weight	4.7 kg
Special features	infinitely variable one-hand height adjustment; maximum stability and legroom; for stationary use
Material	steel
Base diameter	645 mm
Leg construction	fixed screw-in legs
Rod combination	2-piece folding design
Connection stand/plate	prismatic »V-block« connector
Height	from 740 to 1,250 mm
Music desk dimensions	520 x 355 mm

Order No.

black 11950-000-55

ONE-HAND ORCHESTRA MUSIC STAND

11980	STARLINE
Weight	4.68 kg
Special features	infinitely variable one-hand height adjustment; for mobile or stationary use
Material	steel
Base diameter	740 mm
Leg construction	tube legs with cross braces
Rod combination	2-piece folding design
Connection stand/plate	prismatic »V-block« connector
Height	from 785 to 1,290 mm
Music desk dimensions	500 x 340 mm

Order No.

black 11980-000-55

Accessories

Page

Carrying case 11460

44



ORCHESTRA CONDUCTOR STAND

12342

Weight	6.62 kg
Special features	for mobile or stationary use; pull-out music racks on both sides (to 875 mm)
Material	steel stand, wooden desk
Leg construction	tube legs with cross braces
Rod combination	2-piece folding design
Connection stand/plate	screw connection
Height	from 690 to 1,160 mm
Music desk dimensions	575 x 355 mm

Order No.

black 12342-000-55

Accessories

Page

Carrying case 11450

44





SOUND INSULATION STAND

11900

Weight	3.02 kg
Special features	can be used on both sides (concave, convex)
Material	stand steel, plexiglass shield
Base diameter	670 mm
Leg construction	socket with foldable legs
Rod combination	2-piece folding design
Connection stand/shield	prismatic »V-block« connector
Height	from 900 to 1,400 mm
Dimensions shield	450 x 240 mm

Order No.

black 11900-000-55



WOODEN MUSIC STAND

116/1	
Weight	2.81 kg
Material	wood
Rod combination	2-piece folding design
Connection stand/ plate	screw connection
Height	from 715 to 1,225 mm
Music desk dimensions	460 x 300 mm

Order No.

walnut	11611-000-00
beech	11616-000-00
cherrywood	11617-000-00

WOODEN MUSIC STAND

117	
Weight	3.28 kg
Special features	curved baroque design
Material	wood
Rod combination	2-piece folding design
Connection stand/ plate	screw connection
Height	from 960 to 1,320 mm
Music desk dimensions	450 x 310 mm

Order No.

walnut	11701-000-00
beech	11706-000-00
cherrywood	11707-000-00



TABLE MUSIC STAND

124	
Weight	0.28 kg
Special features	Expandable, folding table-top music stand with sheet music retainers; also for zither players
Material	steel
Size when folded	260 x 47 x 37 mm
Music desk dimensions	500 x 200 mm

Order No.

nickel-colored 12400-000-11

UNI-BOY »BOOK« STAND

12440	
Weight	1.98 kg
Special features	for sheet music, books, magazines, reports etc.
Material	plastic
Size when folded	235 x 173 x 13 mm
Music desk dimensions	173 x 235 mm
Angle of inclination	10° to 50°

Order No.

4 color set (unit: 22 pcs.) 12440-000-00
 blue (unit: 12 pcs.) 12440-012-54
 red (unit: 12 pcs.) 12440-012-59
 green (unit: 12 pcs.) 12440-012-60
 yellow (unit: 12 pcs.) 12440-012-61

UNI-BOY »CLASSIC« STAND

12450	
Weight	2.02 kg
Special features	for sheet music, books, magazines, reports etc.
Material	plastic
Size when folded	230 x 173 x 13 mm
Music desk dimensions	173 x 230 mm
Angle of inclination	10° to 50°

Order No.

4 color set (unit: 22 pcs.) 12450-000-00
 blue (unit: 12 pcs.) 12450-012-54
 red (unit: 12 pcs.) 12450-012-59
 green (unit: 12 pcs.) 12450-012-60



MUSIC STAND LIGHT

122e	
Weight	0.37 kg
Special features	CE-mark
Material	steel
Connection	electric cable 2 m
Electrical connection data	230 V AC 50Hz
Intensity	~2500 lux
Clamping range	up to 20 mm
Power output	max. 25 Watt
Lighting appliance	1 light bulb
Lamp shade length	160 mm
Power supply	only mains operation
Light positioning by	pivoted joint

Order No.
black 12250-013-55

Accessories	Page
Replacement bulb 12290	43
LED replacement bulb 12293	43

DOUBLE MUSIC STAND LIGHT

122/6	
Weight	0.52 kg
Special features	CE-mark
Material	steel
Connection	electric cable 2 m
Electrical connection data	230 V AC 50Hz
Intensity	2 x ~2500 lux
Clamping range	up to 20 mm
Power output	max. 25 Watt
Lighting appliance	2 light bulbs
Lamp shade length	320 mm
Power supply	only mains operation
Light positioning by	pivoted joint

Order No.
black 12260-013-55

Accessories	Page
Replacement bulb 12290	43
LED replacement bulb 12293	43

DOUBLE MUSIC STAND LIGHT

12275	
Weight	0.58 kg
Special features	CE-mark
Material	steel
Connection	electric cable 2 m
Electrical connection data	230 V AC 50Hz
Intensity	2 x ~2500 lux
Clamping range	up to 20 mm
Power output	max. 25 Watt
Lighting appliance	2 light bulbs
Lamp shade length	320 mm
Power supply	only mains operation
Light positioning by	gooseneck

Order No.
black 12275-000-55

Accessories	Page
Replacement bulb 12290	43
LED replacement bulb 12293	43



LED PIANO LAMP

12296

Weight	1.6 kg
Special features	includes power adapter; perfect for stage and digital pianos; very bright LED piano lamp; CE-mark
Material	Base zinc die-cast, gooseneck steel, plastic lamp shade
Connection	electric cable 3 m
Electrical connection data	230 V AC 50Hz
Intensity	~2500 lux
Lighting appliance	12 LEDs
Lamp shade length	296 mm
Power supply	only mains operation
Light positioning by	gooseneck

Order No.

black 12296-000-55



Very bright LED piano lamp with 12 LEDs (2500 Lux).

Perfect for stage pianos and digital pianos.



Includes power adapter.

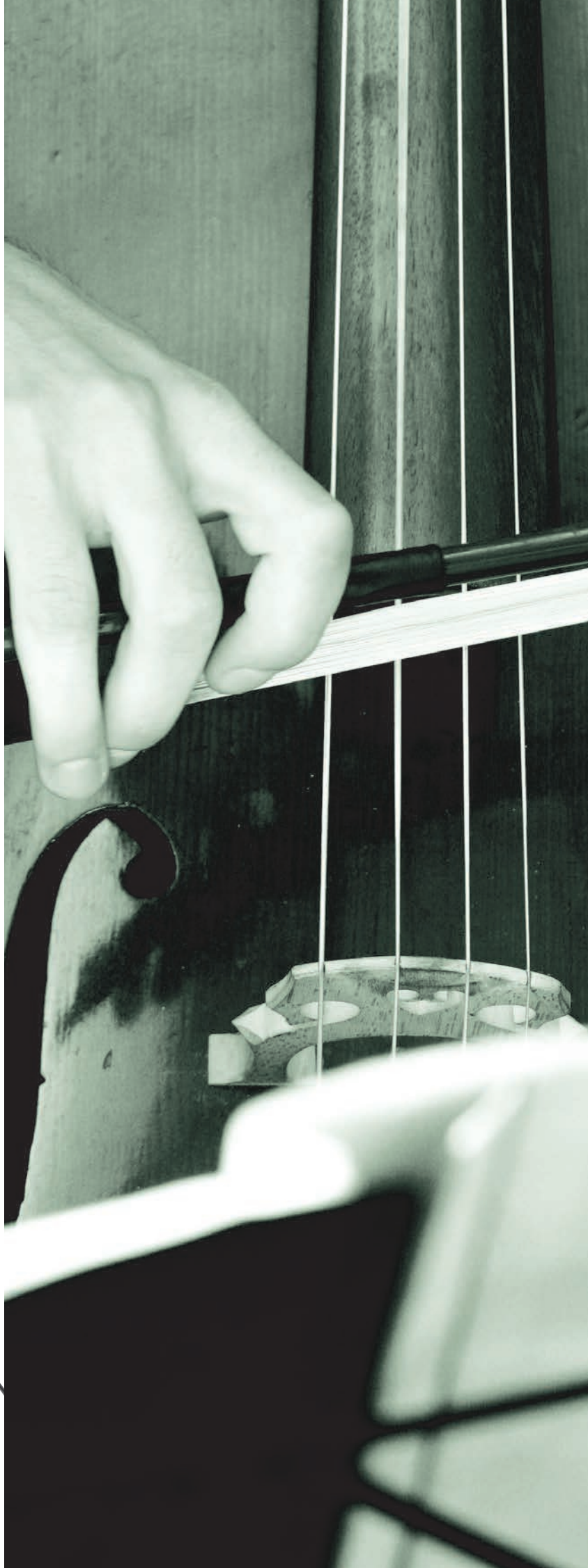

LED PIANO LAMP**12297**

Weight	1.75 kg
Special features	includes power adapter; very bright LED piano lamp; CE-mark
Material	Base zinc die-cast, gooseneck steel, plastic lamp shade
Connection	electric cable 3 m
Electrical connection data	230 V AC 50Hz
Intensity	~2500 lux
Lighting appliance	12 LEDs
Lamp shade length	296 mm
Power supply	only mains operation
Light positioning by	gooseneck

Order No.

gold-colored	12297-000-40
black	12297-000-55
silver	12297-000-63

Piano light with an elegant design. State-of-the-art LED technology guarantees bright light (12 LEDs, 2500 Lux), long life and low energy consumption. Optimum positioning thanks to a long, flexible goose neck (415 mm length). Heavy base ensures stable positioning. Includes power adapter.



Very bright LED piano lamp with 12 LEDs (2500 Lux).



Includes power adapter.



MUSIC STAND LIGHT

NEW

12295

Weight	0.285 kg
Special features	CE-mark; 12 energy saving and durable LEDs; brightness dimmable
Material	steel
Connection	electric cable 3 m
Electrical connection data	110 V - 240 V AC 50Hz - 60Hz
Intensity	2 x ~1400 lux
Clamping range	up to 25 mm
Lighting appliance	2 x 6 LEDs
Lamp shade length	300 mm
Power supply	only mains operation
Light positioning by	gooseneck

Order No.

black 12295-000-55

Perfect lighting for any situation. Equipped with 12 energy saving and durable LEDs guaranteeing optimal music desk lighting. The brightness is adjusted using a variable dimmer switch. The flexible goose neck ensures that the light is ideally positioned. A handy clip provides for easy attachment to all music desks with a thickness of 25 mm. A power supply with a 3 m cord is included.



For music desks up to 25 mm thickness



MUSIC STAND LIGHT »TWIN HEAD«

12270	
Weight	0.28 kg
Special features	newest LED technology; bright and focused light; both light heads work individually
Material	plastic
Size when folded	165 x 100 x 55 mm
Connection	electric cable 3 m
Electrical connection data	110 V - 240 V AC 50Hz - 60Hz
Intensity	2 x ~1400 lux
Clamping range	up to 25 mm
Lighting appliance	2 x 4 LEDs
Power supply	battery operation 3 x Mignon (AA) 1.5 V or mains power with power unit
Light positioning by	goosenecks

Order No.

black 12270-000-55

Another “highlight” from König & Meyer’s range of lights. The exceptionally flexible goose neck allows the musician to choose either a focussed beam or flat light. Each lamp head contains a pack with four LEDs, which can be switched on or off individually. The latest LED technology guarantees a bright source of light, long product life and minimal consumption of energy. The light is attached to surfaces with a maximum thickness of 25 mm using the clip. This multi-purpose attractive lamp functions with batteries or external power supply. The power pack and 3 batteries are included in the delivery.

MUSIC STAND LIGHT

12285	
Weight	0.42 kg
Special features	high-efficiency electric lighting system
Material	gooseneck steel, plastic lamp shade
Intensity	~2500 lux
Clamping range	up to 20 mm
Lighting appliance	1 light bulb
Lamp shade length	240 mm
Power supply	battery operation 3/6/9 x Mignon (AA) 1.5 V or mains power with power unit
Light positioning by	gooseneck

Order No.

black	12285-000-55
-------	--------------

Accessories	Page
Power unit 12280	42
Carrying case 12281	42

MUSIC STAND LIGHT PACKAGE

12286	
Weight	0.7 kg
Special features	K&M battery light 12285 with power unit 12280, packed in an attractive carrying case 12281

Order No.

black	12286-000-55
-------	--------------

READING LIGHT
»MIGHTY BRIGHT - XTRA FLEX 2«

85610	
Weight	0.08 kg
Special features	batteries included
Material	plastic
Intensity	~550 lux
Clamping range	up to 25 mm
Lighting appliance	2 LEDs
Power supply	battery operation 3 x Micro (AAA) 1.5 V or mains power with power unit
Light positioning by	gooseneck

Order No.

blue	85610-000-54
black	85610-000-55
green	85610-000-60
violet	85610-000-65

Accessories	Page
Power unit 85655	42



MUSIC STAND LIGHT
»MIGHTY BRIGHT - XTRA FLEX«

85620	
Weight	0.055 kg
Special features	batteries included
Material	plastic
Intensity	~300 lux
Clamping range	up to 25 mm
Lighting appliance	1 LED
Power supply	battery operation 3 x Micro (AAA) 1.5 V
Light positioning by	gooseneck

Order No.

black	85620-000-55
silver	85620-000-63

Accessories

Magnet holder 85695

Page

42

MUSIC STAND LIGHT
»MIGHTY BRIGHT - DOUBLE FLEX«

85640	
Weight	0.06 kg
Material	plastic
Size when folded	70 x 55 x 50 mm
Intensity	2 x ~400 lux
Clamping range	up to 25 mm
Lighting appliance	2 LEDs
Power supply	battery operation 3 x Micro (AAA) 1.5 V
Light positioning by	goosenecks

Order No.

black	85640-000-55
-------	--------------

Accessories

Magnet holder 85695

Page

42



Flexible adjustable
gooseneck;
Innovative LED
technology



Flexible adjustable
goosenecks;

Innovative LED
technology



MUSIC STAND LIGHT
»MIGHTY BRIGHT - DUET 2«

85650	
Weight	0.11 kg
Special features	4 LEDs switchable individually; batteries included
Material	plastic
Size when folded	90 x 60 x 50 mm
Intensity	2 x ~1000 lux
Clamping range	up to 25 mm
Lighting appliance	2 x 2 LEDs
Power supply	battery operation 3 x Micro (AAA) 1.5 V or mains power with power unit
Light positioning by	goosenecks

Order No.

black 85650-000-55

The useful »Mighty Bright Duet 2« light is the ideal light to take on tour or to use at home. Its flexible goosenecks mean it can easily be adjusted to suit individual needs. Long-life LEDs easily light a 2 x A4-sized surface. A practical attachment clip allows it to be used on music stands or as a standing light. Four bright light diodes to switch on individually are powered optionally by re-chargeable batteries or by a power supply unit.

Accessories	Page
Power unit 85655	42
Magnet holder 85695	42



MUSIC STAND LIGHT
»MIGHTY BRIGHT - PEDAL BOARD LIGHT«

85660	
Weight	0.15 kg
Special features	4 LEDs (2x red, 2 x white) switchable individually; batteries included
Material	plastic
Intensity	1 x ~500 lux and 1 x ~1000 lux
Clamping range	up to 25 mm
Lighting appliance	2 x 2 LEDs
Power supply	battery operation 3 x Micro (AAA) 1.5 V or mains power with power unit
Light positioning by	goosenecks

Order No.
black 85660-000-55

Accessories	Page
Power unit 85655	42
Magnet holder 85695	42

MUSIC STAND LIGHT
»MIGHTY BRIGHT - HAMMER HEAD«

85665	
Weight	0.12 kg
Special features	switch between 2 levels of brightness; batteries included and bag
Material	plastic
Intensity	~1400 lux
Clamping range	up to 25 mm
Lighting appliance	6 LEDs
Lamp shade length	75 mm
Power supply	battery operation 3 x Micro (AAA) 1.5 V or mains power with power unit
Light positioning by	gooseneck

Order No.
black 85665-000-55

Accessories	Page
Power unit 85655	42
Magnet holder 85695	42

MUSIC STAND LIGHT
»MIGHTY BRIGHT - ORCHESTRA LIGHT«

85670	
Weight	0.48 kg
Special features	switch between 2 levels of brightness; inclusive power supply, battery and bag
Material	plastic
Size when folded	297 x 287 x 82 mm
Connection	electric cable 4 m
Electrical	110 V - 240 V AC
connection data	50Hz - 60Hz
Intensity	~1700 lux
Clamping range	up to 20 mm
Lighting appliance	9 LEDs
Lamp shade length	210 mm
Power supply	battery operation 3 x Mignon (AA) 1.5 V or mains power with power unit
Light positioning by	gooseneck

Order No.
black 85670-000-55



MUSIC STAND LIGHT
»MIGHTY BRIGHT - ENCORE LIGHT«

85675

Weight	0.32 kg
Special features	switch between 2 levels of brightness; inclusive power supply, battery and bag
Material	plastic
Size when folded	190 x 180 x 65 mm
Connection	electric cable 4 m
Electrical connection data	110 V - 240 V AC 50Hz - 60Hz
Intensity	~1150 lux
Clamping range	up to 25 mm
Lighting appliance	6 LEDs
Lamp shade length	150 mm
Power supply	battery operation 3 x Micro (AAA) 1.5 V or mains power with power unit
Light positioning by	gooseneck

Order No.

black 85675-000-55

Accessories

Page

Magnet holder 85695

42



MUSIC STAND LIGHT

»MIGHTY BRIGHT - CRESCENDO«

NEW**85690**

Weight	0.35 kg
Special features	CE-mark; 20 energy saving and durable LEDs; brightness dimmable; micro USB charging cable included
Material	plastic
Size when folded	220 x 180 x 30 mm
Connection	USB
Intensity	~1400 lux
Clamping range	up to 12 mm
Lighting appliance	20 LEDs
Lamp shade length	220 mm
Power supply	rechargeable battery
Light positioning by	spring hinge

Order No.

black

85690-000-55

Music stand light in a new innovative design with an energy-efficient and long-lasting LED technology. The light is constructed of flexible elastomer and durable ABS plastic. The brightness is dimmable between 10 and 100 lumens. Battery lifetime is up to 40 hours depending on the brightness setting. The light comes with a battery life indicator. Minimalist design shields light from audience and folds into a compact shape. A sturdy metal clip firmly affixes the light to most music stands. The light charges via micro USB port in 2 hours. Charging cable with micro USB port is included.



1 LED USB LIGHT »MIGHTY BRIGHT«

85681	
Weight	0.06 kg
Special features	illuminates the entire keyboard
Material	plastic
Connection	USB
Lighting appliance	1 LED
Light positioning by	gooseneck

Order No.
silver 85681-000-63

2 LED USB LIGHT »MIGHTY BRIGHT«

85682	
Special features	illuminates the entire keyboard
Material	plastic
Connection	USB
Lighting appliance	2 LEDs
Light positioning by	gooseneck

Order No.
silver 85682-000-63

POWER UNIT

12280	
Weight	0.09 kg
Special features	CE-mark
Connection	electric cable 2 m
Frequency	50-60 Hz
Input	110 to 240 V AC
Output	4.5 V DC
Fits	12285

Order No.
12280-000-00



POWER UNIT

85655	
Weight	0.07 kg
Special features	CE-mark; can also be used as replacement for 12270, 85670 and 85675
Connection	electric cable 3 m
Input	110 to 240 V AC
Output	4 V DC
Fits	85610, 85650, 85660, 85665

Order No.
black 85655-000-00

MAGNET HOLDER

85695	
Weight	0.12 kg
Material	plastic
Fits	85620, 85640, 85650, 85660, 85665, 85675

Order No.
black 85695-000-55

CARRYING CASE

12281	
Weight	0.22 kg
Special features	molded interior recesses for light
Material	nylon
Handle or carrying type	handle
Fastener	zip fastener
Dimensions	290 x 225 x 70 mm
Fits	12285

Order No.
12281-000-00



REPLACEMENT BULB

12290	
Weight	0.02 kg
Electrical connection data	230 V AC 50Hz
Power output	max. 25 Watt
Socket	E 14
Fits	122/6, 12275, 122e

Order No. _____
12290-000-00

LED REPLACEMENT BULB

12293	
Weight	0.02 kg
Electrical connection data	230 V AC 50Hz
Power output	3 Watt
Socket	E 14
Fits	122/6, 12275, 122e

Order No. _____
12293-000-00



CARRYING CASE

10012	
Weight	0.12 kg
Material	nylon
Handle or carrying type	shoulder strap
Fastener	hook-and-loop fastener
Dimensions	500 mm
Fits	100/1, 100/5, 10040, 10062, 10065

Order No. 10012-000-00

CARRYING CASE

10111	
Weight	0.08 kg
Material	nylon
Handle or carrying type	handle
Fastener	hook-and-loop fastener
Dimensions	400 mm
Fits	101

Order No. 10111-000-00

CARRYING CASE

10711	
Weight	0.213 kg
Material	nylon
Handle or carrying type	shoulder strap
Fastener	hook-and-loop fastener
Dimensions	680 mm
Fits	10052, 107

Order No. 10711-000-00



CARRYING CASE

10811	
Weight	0.22 kg
Material	nylon
Handle or carrying type	handle
Fastener	zip fastener
Dimensions	700 mm
Fits	10810, 141/1, 149/9, 14950, 14951, 14985, 15060, 252, 259, 259/1, 25910, 28130

Order No. 10811-000-00

CARRYING CASE

11450	
Weight	0.82 kg
Special features	2 internal compartments and outside pocket for music and accessories
Material	nylon
Handle or carrying type	handle and shoulder straps
Fastener	zip fastener
Dimensions	700 x 120 x 450 mm
Fits	10068, 118/1, 118/5, 11870, 11888, 11899, 12150, 12155, 12179, 12342

Order No. 11450-000-00

CARRYING CASE

11460	
Weight	0.57 kg
Special features	2 internal compartments and outside pocket for music and accessories
Material	nylon
Handle or carrying type	handle
Fastener	zip fastener
Dimensions	820 x 100 x 380 mm
Fits	11940, 11960, 11980

Order No. 11460-000-00



TRAY

122a	
Weight	0.4 kg
Special features	with felt inner-lining
Material	wood
Dimensions	390 x 120 mm
Screw-on to	tube diameter up to 30 mm

Order No.
walnut 12211-000-55



TRAY

12218	
Weight	0.48 kg
Special features	with felt inner-lining
Material	aluminum
Dimensions	390 x 125 mm
Screw-on to	tube diameter up to 30 mm

Order No.
black 12218-000-55



MUSIC HOLDER

131	
Weight	0.32 kg
Special features	folds very small
Material	steel
Screw-on to	tube diameter up to 30 mm

Order No.
black 13100-000-55



FILE HOLDER

13020	
Weight	0.889 kg
Special features	collapsible; 2 additional instrument pegs mountable
Material	steel

Order No.
black 13020-000-55



ADVERTISING PANEL FOR ORCHESTRA MUSIC DESKS

NEW

12384	
Weight	1.9 kg
Special features	for mounting to orchestra music desks; two clamps included
Material	aluminum
Dimensions	520 x 800 x 1.5 mm

Order No.
black 12384-000-55



MAGNET

115/6	
Weight	0.035 kg
Special features	with felt lining; imprint of customer logos is possible
Dimensions	58 x 27 mm

Order No.
black with K&M logo 11560-000-55
black with customer logo (plus charges for special logo) 11561-000-55



POWER MAGNET

11580

Weight	0.052 kg
Special features	Strong magnetic power - mini size; 2 magnets in blister packaging
Material	steel
Dimensions diameter	12 x 16 mm

Order No.

zinc-plated (unit: 2 pcs.)	11580-000-29
zinc-plated (unit: 10 pcs. in PET bag)	11581-000-29



SHEET MUSIC HOLDER

11590

Weight	0.014 kg
Special features	suitable for the music stands product groups »Baseline« and »Topline«; easy to use; folds small
Material	plastic
Dimensions	78 x 30 x 10 mm

Order No.

black	11590-000-55
-------	--------------



SHEET MUSIC CLIP

16060

Weight	0.014 kg
Special features	4 pieces in a poly bag
Material	plastic
Dimensions	51 x 50 x 22 mm

Order No.

black (unit: 4 pcs.)	16060-000-55
black (unit: 100 pcs.)	16060-100-55



DRINK HOLDER

160/2

Weight	0.24 kg
Material	steel
Screw-on to	tube diameter up to 30 mm
Suitable for	bottles, glasses and cups with maximum diameter of 85 mm

Order No.

black	16020-000-55
-------	--------------



UNIVERSAL DRINK HOLDER

16022

Weight	0.389 kg
Material	steel
Screw-on to	tube diameter up to 30 mm
Suitable for	bottles, glasses and cups with maximum diameter of 95 mm

Order No.

black	16022-000-55
-------	--------------



ASHTRAY

16015

Weight	0.222 kg
Special features	with sliding lid
Material	plastic
Dimensions	103 x 60 x 70 mm
Screw-on to	tube diameter up to 30 mm

Order No.

black	16015-013-55
-------	--------------



PENCIL HOLDER

16092	
Weight	0.002 kg
Material	plastic
Suitable for tubing diameter of	13 to 15 mm

Order No.
black 16092-000-55



PENCIL HOLDER

16094	
Weight	0.003 kg
Material	plastic
Suitable for tubing diameter of	20 to 22 mm

Order No.
black 16094-000-55



PENCIL HOLDER

16096	
Weight	0.004 kg
Material	plastic
Suitable for tubing diameter of	24 to 26 mm

Order No.
black 16096-000-55



K&M KÖNIG & MEYER
Stands For Music



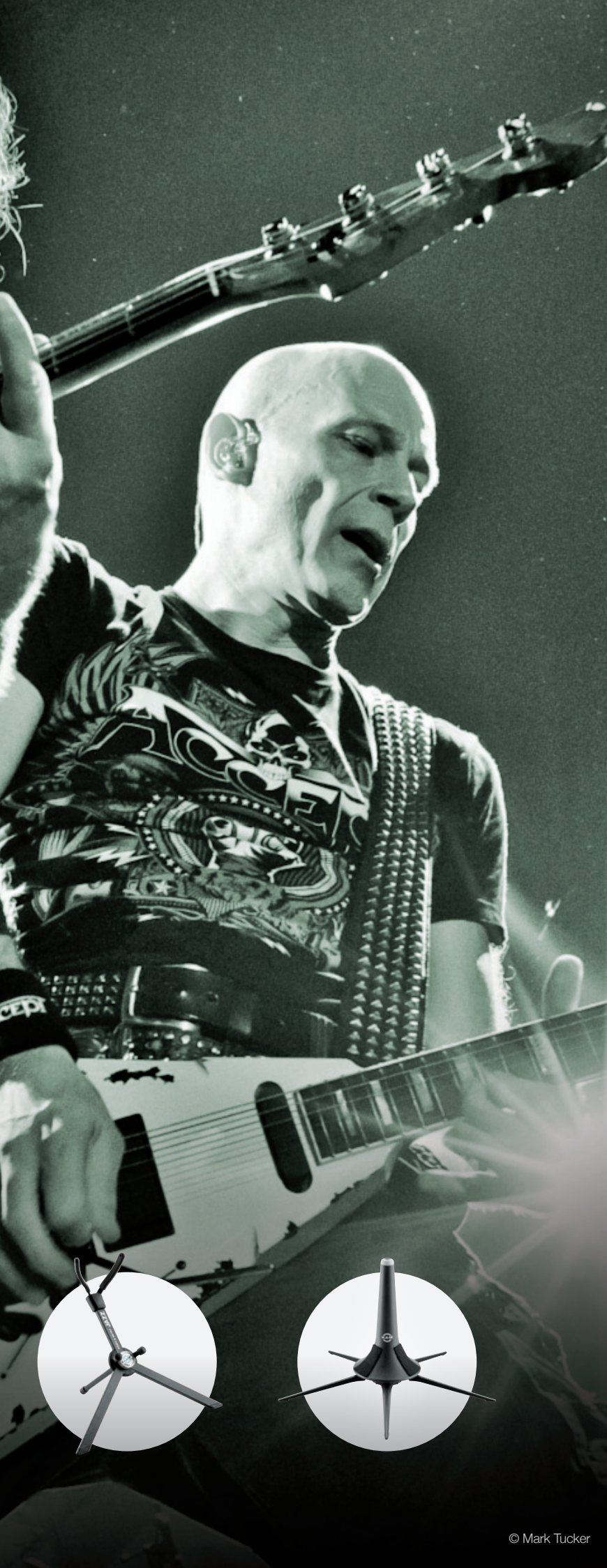

STANDS AND ACCESSORIES FOR INSTRUMENTS

From all-round guitar stands to stands for rare musical instruments, König & Meyer offers a wide range of professional instrument stands. Continually tested, tweaked and refined, many of these stands have set the standard for functionality and workmanship for many years.

Behind every innovation there is 60 years of experience and expertise – expertise that allows us to develop instrument stands that precisely and compactly guarantee the very best footing for your instrument.



**E-GUITAR STAND****17540**

Weight	1.86 kg
Material	steel
Instrument support	non-marring plastic material
Suitable for	electric guitars
Adjustment	push-button system
Width-adjustable	from 220 to 350 mm
Height	420 mm

Order No.

black	17540-013-55
cork	17540-013-95

A-GUITAR STAND**17541**

Weight	1.93 kg
Material	steel
Instrument support	non-marring plastic material
Suitable for	acoustic guitars
Adjustment	push-button system
Width-adjustable	from 220 to 350 mm
Height	420 mm

Order No.

black	17541-013-55
cork	17541-013-95

GUITAR STAND »MEMPHIS TRAVEL«**17550**

Weight	0.46 kg
Special features	fits in almost every Gig Bag; very light; folds very small; instrument support arms adjust to fit various guitar sizes; the two feet which can be folded out at the front ensure additional stability
Material	aluminum
Instrument support	non-marring plastic material
Suitable for	acoustic and electric guitars
Support depth	from 68 to 127 mm
Size when folded	290 mm
Height	275 mm

Order No.

black anodized	17550-000-35
----------------	--------------

Stable and easy to adjust and fold by push-button system



With exclusive non-marring material to protect instrument finishes

Fits in almost every Gig Bag



Adjustable support arms for electric and acoustic guitars



p02e.k-m.de
Product video

E+A GUITAR STAND »DUET«

17570

Weight	1.23 kg
Special features	integrated pick holder
Material	steel
Instrument support	non-marring plastic material
Suitable for	acoustic and electric guitars
Adjustment	push-button system
Width-adjustable	from 195 to 255 mm
Size when folded	310 x 81 x 410 mm
Height	375 mm

Order No.

black with translucent support elements 17570-000-00

Stable and easy to adjust and fold by push-button system



With exclusive non-marring material to protect instrument finishes





With pick holders

**A-GUITAR STAND »HELI 2«****17580**

Weight	0.95 kg
Special features	also for headless guitars, cellos and french horns; easy to transport and store; integrated guitar pick holders, 2 picks included
Material	steel
Instrument support	non-marring plastic material
Suitable for	acoustic guitars
Adjustment	foldable by bracket with hinge
Width-adjustable	from 185 to 230 mm
Size when folded	365 x 295 x 30 mm
Height	330 mm

Order No.

blue	17580-014-54
black	17580-014-55
red	17580-014-59
cork	17580-014-95

The completely revised world-renowned classic stand is presented in a new look. The instrument is particularly well cared for thanks to the elaborate new rubber structure. With the new innovative adjustable cross bar, guitars of different sizes or even other instruments such as a cello or French horn can be placed on the stand. For storage and transport the stand folds flat. In addition, we provide a practical transport lock. An additional feature includes integrated guitar pick holders. Heli 2 is available in black, red, blue and cork.

E-GUITAR STAND »HELI 2«

17581	
Weight	1.32 kg
Special features	New in 4 positions adjustable support system
Material	steel
Instrument support	non-marring plastic material
Suitable for	electric guitars
Adjustment	foldable by bracket with hinge
Width-adjustable	from 185 to 230 mm
Size when folded	380 x 290 x 33 mm
Height	350 mm

Order No.

black	17581-014-55
cork	17581-014-95

E-GUITAR STAND »WAVE 20«

17590	
Weight	0.48 kg
Material	plastic
Suitable for	electric guitars
Adjustment	5-way width adjustable by two cross braces with inserted screw
Support depth	58 mm
Size when folded	290 x 25 x 210 mm
Height	290 mm

Order No.

black	17590-000-55
-------	--------------

A-GUITAR STAND »WAVE 10«

17591	
Weight	0.6 kg
Special features	also for french horns, cellos, banjos
Material	plastic
Suitable for	acoustic guitars
Adjustment	5-way width adjustable by two cross braces with inserted screw
Support depth	135 mm
Size when folded	290 x 25 x 320 mm
Height	320 mm

Order No.

black	17591-000-55
-------	--------------



New in 4 positions adjustable support system

**GUITAR STAND »MEMPHIS 20«**

17685	
Weight	1.08 kg
Special features	instrument support arms adjust to fit various guitar sizes
Material	steel
Instrument support	non-marring plastic material
Suitable for	acoustic and electric guitars
Adjustment	clamp lever(s)
Support depth	from 68 to 127 mm
Height	735 mm
Yoke	with safety strap

Order No.

black 17685-000-55

GUITAR STAND »MEMPHIS 10«

17680	
Weight	1.6 kg
Special features	anti-twist feature on the extension rod
Material	steel
Instrument support	foam pads
Suitable for	acoustic and electric guitars
Rod combination	2-piece folding design
Adjustment	clamp lever(s)
Height	from 550 to 1,120 mm
Yoke	with safety strap

Order No.

black 17680-000-55

GUITAR STAND »MEMPHIS PRO«

17670	
Weight	1.5 kg
Special features	folds small; patented flexible hooking-in and clamping system; studs at support arms provide extra protection; anti-twist feature on the extension rod; suitable for asymmetric guitar necks
Material	steel
Instrument support	non-marring rubber
Suitable for	acoustic and electric guitars
Rod combination	2-piece folding design
Adjustment	clamp lever(s)
Height	from 550 to 1,000 mm
Yoke	self-locking

Order No.

black 17670-000-55

p03e.k-m.de
Product video

GUITAR STAND »DOUBLE«

17620

Weight	2.053 kg
Special features	to hook 2 guitars; suitable for all guitars with head- stock, basses, acoustic guitars, ukuleles, banjos etc.
Material	steel
Base diameter	760 mm
Instrument support	non-marring plastic material
Suitable for	acoustic and electric guitars
Rod combination	2-piece folding design
Size when folded	750 x 260 mm
Height	from 800 to 1,300 mm
Yoke	self-locking

Order No.

black 17620-000-55

Accessories

Page

Carrying case 18846

142



The patented hanger is suitable for all types of guitar headstocks





Suitable for unusually shaped guitars



Foldable for transport



p09e.k-m.de
Product video

FOUR GUITAR STAND »ROADIE«

17604

Weight	4.79 kg
Special features	suitable for 4 guitars; also for special V- and X-shaped guitar models; also suitable for guitars with attached cable connectors and straps; foldable for transport
Material	steel
Instrument support	non-marring plastic material
Suitable for	acoustic and electric guitars
Rod combination	2-piece folding design
Adjustment	in 3 steps
Base dimensions	660 x 350 mm
Height	from 1,030 to 1,185 mm
Yoke	fixed

Order No.

black 17604-000-55

Have you ever inadvertently left your guitar on top of a cable or jack plug? It simply cannot happen with this unique four guitar stand. The newly developed guitar stand is the ideal stage companion, but it also does a superb job in the studio or at home. Thanks to the moveable hanger and easy height adjustment, up to 4 acoustic, electric and bass guitars are always easy to hand and ready for playing. Even unusually shaped guitars can be stored safely. Large soft foam rolls protect the guitars from inadvertent knocks or bumps. The "fit-for-tour" steel tube construction is stable and durable. The base legs can be folded with little effort into a compact and flat package for transport.



p08e.k-m.de
Product video



Translucent elements -
suitable for guitars with
nitro laquer

Foldable



For electric guitars



FIVE E-GUITAR STAND »GUARDIAN 5«

17525

Weight	4.7 kg
Special features	Protective bars prevent damage from bumps or knocking; holds the guitar's neck without touching the strings; integrated pick holders
Material	plastic
Instrument support	non-marring plastic material
Suitable for	electric guitars
Base dimensions	688 x 335 mm
Size when folded	688 x 670 x 173 mm
Height	700 mm

Order No.

black with translucent
support elements 17525-000-00

Guardian securely holds up to 5 E-guitars or base guitars, saving space. Specifically adjusted and cushioned rests provide a secure and protective grip. The flexible protective arms protect the guitar from moving and provide protection when putting down or picking up the guitar from mistakenly hitting the frame of the stand. The soft pads are equipped with cushioning qualities. They softly support the guitars weight and avoid any damage to the instrument. The Guardian is easy to transport and carry and thanks to an innovative folding mechanism, it can even be stored in an upright position. Flexible, proportioned system arms with integrated pick holders allow the guitars to be put down both on the right or the left side, and also ensures that the guitar strings are not touching anything. The translucent elements ensure that discoloration does not occur as a result of nitro-coatings.

**FIVE GUITAR STAND »GUARDIAN 5«**

17515	
Weight	4.65 kg
Special features	Protective bars prevent damage from bumps or knocking; additional slots for electric guitars; holds the guitar's neck without touching the strings; integrated pick holders
Material	plastic
Instrument support	non-marring plastic material
Suitable for	acoustic and electric guitars
Base dimensions	996 x 335 mm
Size when folded	996 x 670 x 173 mm
Height	700 mm

Order No.

black with translucent support elements	17515-000-00
black	17515-000-55

THREE GUITAR STAND »GUARDIAN 3«

17513	
Weight	3.6 kg
Special features	Protective bars prevent damage from bumps or knocking; additional slots for electric guitars; holds the guitar's neck without touching the strings; integrated pick holders
Material	plastic
Instrument support	non-marring plastic material
Suitable for	acoustic and electric guitars
Base dimensions	626 x 335 mm
Size when folded	626 x 670 x 173 mm
Height	700 mm

Order No.

black with translucent support elements	17513-000-00
black	17513-000-55

GUITAR PERFORMER STAND

14760	
Weight	3.29 kg
Special features	angle and length adjust to your needs
Material	steel
Instrument support	felt-lined
Suitable for	electric guitars
Rod combination	3-piece folding design
Size when folded	790 mm
Height	from 690 to 1,550 mm
Suitable for instrument widths	from 39 to 60 mm

Order No.

black	14760-000-55
-------	--------------

Accessories

Carrying case 18846

Page

142



Translucent elements - suitable for guitars with nitro laquer



Foldable



p08e.k-m.de
Product video

GUITAR PERFORMER STAND

14761	
Weight	2.23 kg
Special features	angle and length adjust to your needs
Material	steel
Instrument support	felt-lined
Suitable for	acoustic guitars
Rod combination	3-piece folding design
Size when folded	790 mm
Height	from 690 to 1,550 mm
Suitable for instrument widths	from 75 to 135 mm

Order No.
black 14761-000-55

Accessories	Page
Carrying case 18846	142

GUITAR HOLDER

16150	
Weight	0.195 kg
Special features	clamp suitable for tube diameter 15 mm; elastic ring suitable for tube diameter from 19 to 20 mm; incl. pick support
Material	steel

Order No.
black 16150-000-55

GUITAR WALL MOUNT

162	
Weight	0.16 kg
Special features	two fastening points
Material	steel
Instrument support	non-marring plastic material
Suitable for	acoustic and electric guitars
Direction	forward-turned
Yoke	fixed
Dimensions	84 x 215 x 150 mm

Order No.
black 16200-000-55



**GUITAR WALL MOUNT****16220**

Weight	0.13 kg
Material	wood
Instrument support	non-marring plastic material
Suitable for	acoustic and electric guitars
Size when folded	115 x 82 x 55 mm
Direction	forward-turned
Yoke	fixed
Dimensions	82 x 100 x 115 mm

Order No.

cork	16220-000-95
------	--------------

GUITAR WALL MOUNT**16280**

Weight	0.155 kg
Material	plastic, steel
Instrument support	non-marring plastic material
Suitable for	acoustic and electric guitars
Direction	forward-turned
Yoke	self-locking
Dimensions	94 x 66 x 138 mm

Order No.

black	16280-000-55
cork	16280-000-95
white with translucent support elements	16280-014-00

GUITAR WALL MOUNT**16250**

Weight	0.17 kg
Special features	additional guard cams prevent guitar from turning; automatic back release mechanism; support arms work individually; suitable for asymmetric guitar necks
Material	plastic, steel
Instrument support	non-marring plastic material
Suitable for	acoustic and electric guitars
Direction	forward-turned
Yoke	self-locking
Dimensions	80 x 60 x 116 mm

Order No.

black	16250-000-55
-------	--------------



GUITAR WALL MOUNT

16240	
Weight	0.2 kg
Special features	patented flexible hooking-in and clamping system; studs at support arms provide extra protection; suitable for asymmetric guitar necks
Material	plastic, steel
Instrument support	non-marring plastic material
Suitable for	acoustic and electric guitars
Direction	forward-turned
Yoke	self-locking
Dimensions	84 x 108 x 152 mm

Order No.
black 16240-000-55

GUITAR WALL MOUNT

16235	
Weight	0.24 kg
Material	steel
Instrument support	non-marring plastic material
Suitable for	acoustic and electric guitars
Direction	left or right turned
Yoke	fixed
Dimensions	300 x 108 x 70 mm

Order No.
black 16235-000-55

GUITAR WALL MOUNT

16255	
Weight	0.45 kg
Material	steel
Instrument support	non-marring plastic material
Suitable for	acoustic and electric guitars
Direction	left or right turned
Yoke	self-locking
Dimensions	300 x 153 x 70 mm

Order No.
black with translucent support elements 16255-000-00
black 16255-000-55



WALL MOUNT FOR ELECTRIC GUITAR

16295	
Weight	1.17 kg
Special features	flexible support arms for neck and body
Material	steel
Instrument support	silicone cover
Suitable for	electric guitars
Size when folded	565 x 230 x 150 mm
Direction	in 8° settings 360° adjustable
Dimensions	690 x 220 x 155 mm

Order No.

black 16295-000-55

WALL MOUNT FOR ACOUSTIC GUITAR

16296	
Weight	1.14 kg
Special features	flexible support arms for neck and body
Material	steel
Instrument support	silicone cover
Suitable for	acoustic guitars
Size when folded	565 x 230 x 150 mm
Direction	in 8° settings 360° adjustable
Dimensions	690 x 220 x 205 mm

Order No.

black 16296-000-55

FOOTREST

14640	
Weight	0.31 kg
Material	aluminum, plastic
Height adjustment	4 different positions
Height	from 105 to 180 mm
Dimensions	202 x 91 mm

Order No.

black 14640-000-55



FOOTREST

14670

Weight	0.6 kg
Special features	non-skid plastic pad
Material	steel
Height adjustment	6 different positions
Height	from 119 to 264 mm
Dimensions	250 x 98 mm

Order No.

nickel-colored	14670-014-11
blue	14670-014-54
black	14670-014-55
red	14670-014-59



**GUITAR CAPO****14530**

Weight	0.05 kg
Special features	ergonomic design; no „string bend“ - tuning is not affected; unique clamping mechanism, easy to operate
Material	zinc die-cast frame
Instrument support	non-marring plastic material
Finger board	flat
Clamping	one-step push and release system
Clamping range	20 to 30 mm
Dimensions	72 x 14 x 65 mm

Order No.

mat chrome

14530-000-06

This appealing, ergonomically designed and easy-to-use professional capo is for nearly all six and twelve string guitars with flat or slightly curved fingerboards. A long product life is a given for this robust zinc die-cast model with high-quality craftsmanship. The parallel clamping mechanism permits precise contact pressure and adjustment plus a quick release.

GUITAR CAPO

14535	
Weight	0.06 kg
Special features	ergonomic design; no „string bend“ - tuning is not affected; unique clamping mechanism, easy to operate
Material	zinc die-cast frame
Instrument support	non-marring plastic material
Finger board	curved
Clamping	one-step push and release system
Clamping range	20 to 30 mm
Dimensions	72 x 14 x 65 mm

Order No.
mat chrome 14535-000-06

GUITAR CAPO

14540	
Weight	0.074 kg
Special features	no „string bend“ - tuning is not affected; simple and fast to mount
Material	plastic
Instrument support	non-marring plastic material
Finger board	flat
Clamping	locking screw
Clamping range	20 to 30 mm
Dimensions	78 x 18 x 85 mm

Order No.
black 14540-000-55

GUITAR CAPO

14545	
Weight	0.074 kg
Special features	no „string bend“ - tuning is not affected; simple and fast to mount
Material	plastic
Instrument support	non-marring plastic material
Finger board	curved
Clamping	locking screw
Clamping range	20 to 30 mm
Dimensions	78 x 18 x 85 mm

Order No.
black 14545-000-55



GUITAR CAPO

NEW

30900

Weight	0.038 kg
Special features	lightweight aluminum construction; quickly adjustable with one hand; does not obstruct playing; for Western-style and electric guitars
Material	zinc die-cast frame
Instrument support	non-marring slip-proof pad
Finger board	curved
Clamping	spring-tension
Clamping range	20 to 30 mm
Dimensions	70 x 16 x 92 mm

Order No.

matt chrome 30900-000-02

GUITAR PLAYING-AID »POHLMANN«

14580

Weight	0.075 kg
Material	plastic
Instrument support	non-marring rubber
Dimensions	65 x 40 x 112 mm

Order No.

black 14580-000-55



A quick and clever alternative to a guitar strap. The "Pohlmann" allows you more freedom when handling your guitar.

GUITAR TOOL

83845

Weight	0.15 kg
Special features	Carbide steel blade cuts all strings, even bass strings
Material	steel
Consisting of	hardened steel hex wrenches (1.5 mm, 2.5 mm, 3 mm, .050 hex), Phillips head screwdriver, flat head screwdriver, and a bridge pin puller

Order No.

83845-000-00



Quickly adjustable with one hand; does not obstruct playing



UKULELE HOLDER

NEW

15590	
Weight	0.137 kg
Special features	rubberized support arms
Material	steel, plastic
Dimensions	66 x 116 x 60 mm
Screw-on to	tube diameter up to 30 mm

Order No.

black 15590-000-55

UKULELE WALL MOUNT

NEW

16590	
Weight	0.093 kg
Material	plastic, steel
Instrument support	non-marring plastic material
Suitable for	ukulele
Direction	forward-turned
Yoke	fixed
Dimensions	80 x 66 x 102 mm

Order No.

black 16590-000-55



HACKBRETT STAND

28070	
Weight	7.22 kg
Special features	length and width adjustable; folding base for easy transportation; additional levelling screw for uneven surfaces
Material	steel
Instrument support	felt-lined
Adjustment	support arms gradual in 15° settings
Height adjustment	spring-loaded clamping knob
Angle of inclination	0° to 45°
Support depth	from 455 to 665 mm
Support width	from 310 to 500 mm
Height	from 700 to 1,020 mm
Leg construction	collapsible square tube legs
Number of legs	4 pieces

Order No.

black 28070-070-55

Accessories

Accessories	Page
Carrying case 21311	230
Music holder 11515	68
Carrying case »Pro« 21312	231



MUSIC HOLDER FOR HACKBRETT STAND 28070

11515	
Weight	0.95 kg
Material	steel
Music desk	traditionally foldable
Music desk dimensions	485 x 240 x 42 mm
Fits	28070

Order No.

black 11515-000-55

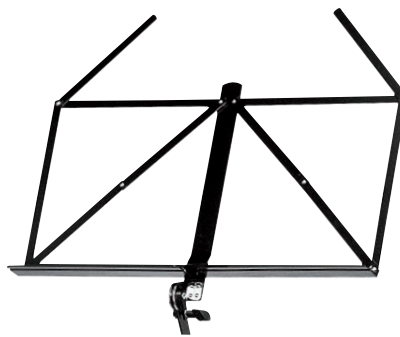

VIOLIN HOLDER

15580	
Weight	0.11 kg
Special features	high quality flocking cover; with holder for bow
Material	plastic yoke, steel clamp
Screw-on to	tube diameter up to 30 mm
Instrument support	flocked

Order No.
black 15580-000-55

VIOLIN WALL HOLDER

16580	
Weight	0.08 kg
Special features	high quality flocking cover; with holder for bow
Material	plastic
Instrument support	flocked

Order No.
black 16580-000-55

VIOLIN STAND

15520	
Weight	0.64 kg
Material	aluminum
Instrument support	non-marring plastic material
Adjustment	foldable by bracket with hinge
Height	365 mm

Order No.
black 15520-000-55



Secure grip



Holder for bow





VIOLIN STAND

15530	
Weight	0.52 kg
Special features	folds small; comes with a nylon bag; integrated bow holder; for various violin models
Material	aluminum
Instrument support	non-marring plastic material
Adjustment	clamp lever(s)
Size when folded	350 x 110 x 70 mm
Height	from 360 to 570 mm
Yoke	with safety strap

Order No.	
black	15530-000-55

VIOLIN/UKULELE DISPLAY STAND

15550	
Weight	0.15 kg
Special features	for small string instruments, such as violins or ukuleles; folds small
Material	plastic
Instrument support	non-marring plastic material
Height	205 mm

Order No.	
wooden look	15550-000-98

CELLO STAND

141/1	
Weight	2.54 kg
Special features	bow holder included
Material	steel
Instrument support	non-marring plastic material
Base diameter	800 mm
Support width	380 mm
Size when folded	175 x 130 x 605 mm
Height	from 620 to 1,120 mm
Leg construction	tube legs with cross braces
Suitable for	all cellos
Rod combination	2-piece folding design

Order No.	
black	14110-011-55

Accessories	Page
Carrying case 10811	44
Carrying case 14102	76



Display Stand for small string instruments, such as violins or ukuleles



CELLO STAND

14130	
Weight	2.362 kg
Special features	bow holder included; adjustable end cap to stabilize the stand on uneven surfaces
Material	steel
Instrument support	non-marring plastic material
Adjustment	push-button system
Width-adjustable	from 285 to 450 mm
Size when folded	335 x 90 x 580 mm
Height	535 mm
Suitable for	all cellos

Order No.

cork 14130-000-95

DOUBLE BASS STAND

141	
Weight	2.6 kg
Special features	bow holder included
Material	steel
Instrument support	non-marring plastic material
Base diameter	800 mm
Support width	405 mm
Size when folded	175 x 130 x 605 mm
Height	from 620 to 1,120 mm
Leg construction	tube legs with cross braces
Suitable for	all string basses
Rod combination	2-piece folding design

Order No.

black 14100-011-55

Accessories

Carrying case 14102 76

STAND FOR ELECTRIC DOUBLE BASS

14160	
Weight	2.78 kg
Special features	flocked bow holder included; support width can be adjusted individually to the size of the instrument
Material	steel
Instrument support	non-marring plastic material
Base diameter	800 mm
Support width	from 75 to 155 mm
Size when folded	115 x 150 x 890 mm
Height	from 920 to 1,620 mm
Leg construction	tube legs with cross braces
Suitable for	electric double bass
Rod combination	2-piece folding design

Order No.

black 14160-000-55

Accessories

Universal carrying case 15043 75
Carrying case 18846 142



**SAXOPHONE STAND**

14300	
Weight	1 kg
Special features	fiberglass reinforced plastic base; flexible upper support arm; lower support arm bracket with several vertical locking positions
Material	steel
Leg construction	socket with foldable legs
Instrument support	non-marring plastic material
Suitable for	Eb Alto and Bb Tenor Sax
Height	485 mm

Order No.

black 14300-000-55

Accessories

Accessories	Page
Peg holder 14301	95
Carrying case 14303	72

SOPRANO SAXOPHONE STAND

14315	
Weight	1 kg
Special features	fiberglass reinforced plastic base; flexible upper support arm; lower support arm bracket with several vertical locking positions
Material	steel
Leg construction	socket with foldable legs
Instrument support	non-marring plastic material
Suitable for	curved Soprano Saxophones
Height	485 mm

Order No.

black 14315-000-55

Accessories

Accessories	Page
Peg holder 14301	95
Carrying case 14303	72

CARRYING CASE

14303	
Special features	for 2 saxophones or other instrument combinations like 1 x 14300 and 1 x music stand 101; with 2 internal compartments
Material	nylon
Dimensions	470 x 200 x 150 mm
Handle or carrying type	handle
Fastener	zip fastener
Fits	14300, 14315, 14945, 14952, 25950

Order No.

14303-000-00

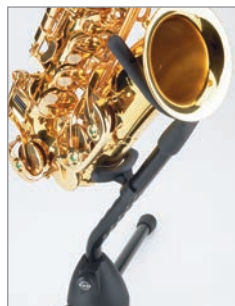

Covered with exclusive non-marring material

Flexible upper support arm



SAXOPHONE STAND »JAZZ«

14330	
Weight	0.292 kg
Special features	folds very small; easy-to-use; can be transported in the supplied velour bag in the saxophone bell; embedded foot end caps
Material	aluminum
Instrument support	non-marring plastic material
Suitable for	Eb alto saxophones
Adjustment	central locking screw
Height	310 mm

Order No.
black 14330-000-55

SAXOPHONE STAND »JAZZ«

14335	
Weight	0.36 kg
Special features	folds very small; easy-to-use; can be transported in the supplied velour bag in the saxophone bell; embedded foot end caps
Material	aluminum
Instrument support	non-marring plastic material
Suitable for	Bb tenor saxophones
Adjustment	central locking screw
Height	425 mm

Order No.
black 14335-000-55

SAXOPHONE STAND »SAXXY«

14340	
Weight	0.36 kg
Special features	folds very small; can be transported in the supplied velour bag in the saxophone bell
Material	steel
Instrument support	non-marring plastic material
Suitable for	Eb alto saxophones
Height	300 mm

Order No.
black 14340-000-55

Comes with a velour bag



Folds very small



Folds very small



Comes with a velour bag



**SAXOPHONE STAND »SAXXY«**

14350	
Weight	0.58 kg
Special features	folds very small; can be transported in the supplied velour bag in the saxophone bell
Material	steel
Instrument support	non-marring plastic material
Suitable for	Bb tenor saxophones
Height	420 mm

Order No.

black 14350-000-55

BARITONE SAXOPHONE STAND

144/1	
Weight	1.42 kg
Special features	adjustable lower support arm bracket
Material	steel
Leg construction	tube legs with cross braces
Instrument support	non-marring plastic material
Suitable for	baritone saxophones
Height	from 790 to 915 mm
Rod combination	2-piece folding design

Order No.

black 14410-000-55

SOPRANO SAXOPHONE STAND

15290	
Weight	0.34 kg
Special features	The detachable metal leg base screws into the peg so that the entire unit can be stored in the bell of the instrument for easy transport
Material	plastic
Leg construction	leg base screwable
Instrument support	felt pads
Height	250 mm
Number of legs	5 pieces

Order No.

black 15290-000-55

Comes with a velour bag



Folds very small

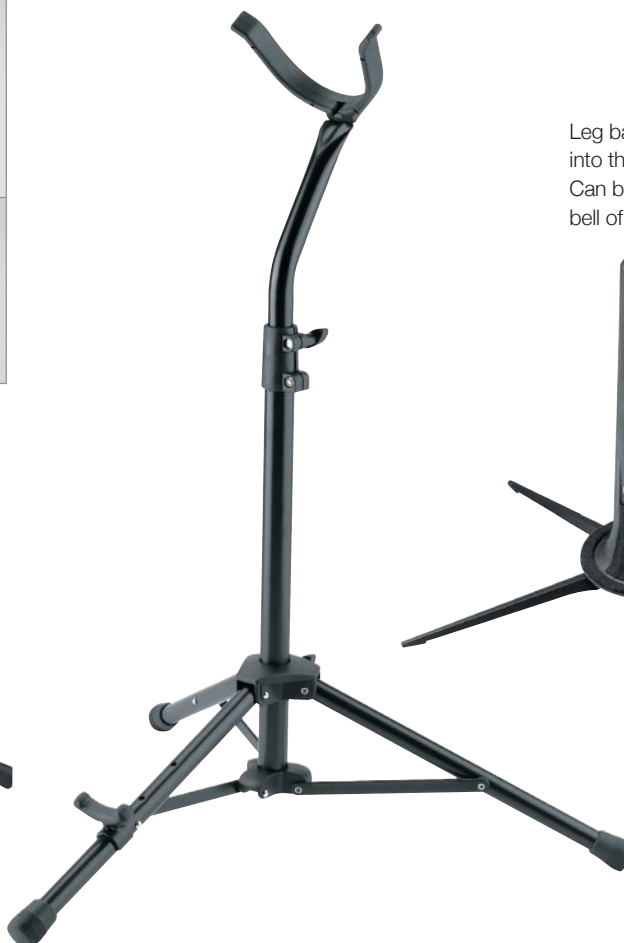

Leg base screws into the peg.
Can be stored in the bell of the instrument.



BASSOON STAND

150/1	
Weight	2.9 kg
Special features	support width can be adjusted individually to the size of the instrument
Material	steel
Base diameter	800 mm
Leg construction	tube legs with cross braces
Instrument support	felt-lined
Suitable for	bassoon
Size when folded	185 x 135 x 645 mm
Height	from 700 to 1,200 mm
Support width	from 57 to 87 mm
Rod combination	2-piece folding design

Order No.	
black	15010-011-55

Accessories	Page
Carrying case 14102	76
Universal carrying case 15043	75

CONTRABASSOON STAND

15045	
Weight	3.1 kg
Material	steel
Base diameter	800 mm
Leg construction	tube legs with cross braces
Instrument support	felt-lined
Suitable for	contra bassoon
Size when folded	175 x 115 x 605 mm
Height	from 700 to 1,200 mm
Support width	262 mm
Rod combination	2-piece folding design

Order No.	
black	15045-011-55

Accessories	Page
Carrying case 18846	142
Universal carrying case 15043	75

UNIVERSAL CARRYING CASE

15043	
Special features	comes with separate internal compartments
Material	nylon
Dimensions	1,000 x 180 x 180 mm
Handle or carrying type	handle and shoulder straps
Fastener	zip fastener
Fits	14160, 150/1, 15045, 21339, 21340

Order No.	
	15043-000-00



CARRYING CASE

14102

Weight	0.45 kg
Material	nylon
Dimensions	700 x 150 x 130 mm
Handle or carrying type	handle
Fastener	zip fastener
Fits	141, 141/1, 150/1, 15060

Order No.

14102-000-00





Support bracket - protective and adjustable

Newly developed V-shaped base for the endpin



BASS CLARINET STAND

15060	
Weight	2.9 kg
Special features	support width can be adjusted individually to the size of the instrument
Material	steel
Base diameter	800 mm
Leg construction	tube legs with cross braces
Instrument support	felt-lined
Suitable for	bass clarinet
Size when folded	120 x 120 x 645 mm
Height	from 700 to 1,200 mm
Support width	from 57 to 87 mm
Rod combination	2-piece folding design

Order No.

black 15060-011-55

The universal support bracket can be adjusted in tilt and width. The support bracket can be adjusted to the individual instrument by converting the removable rubber pads. The newly designed V-shaped base for the endpin means it is easy to position the instrument in the stand. The stand is easy to fold compactly for transport.

Accessories

Accessories	Page
Carrying case 10811	44
Carrying case 14102	76



**CLARINET STAND****152/2**

Weight	0.12 kg
Material	plastic peg, steel legs
Leg construction	foldable legs
Suitable for	A and B clarinets
Height	185 mm
Number of legs	3 pieces

Order No.

nickel 15220-000-01

CLARINET STAND**15222**

Weight	0.12 kg
Special features	detachable metal leg base screws into the peg so that the entire unit can be stored in the bell of the instrument; with felt ring
Material	plastic peg, zinc die-cast legs
Leg construction	leg base screwable
Suitable for	all current models of clarinets
Height	180 mm
Number of legs	4 pieces

Order No.

black 15222-000-55

CLARINET HOLDER**15225**

Weight	0.21 kg
Special features	with felt ring
Material	plastic
Suitable for	A and B clarinets
Screw-on to	tube diameter up to 30 mm
Height	210 mm

Order No.

black 15225-000-55

Felt protective ring



Leg base screws into the peg.
Can be stored in the bell of the instrument.



Felt protective ring

CLARINET STAND

15227	
Weight	0.6 kg
Special features	suitable for microphoned clarinets; with felt ring
Material	plastic peg, steel
Base diameter	350 mm
Leg construction	square tube legs snap into socket
Suitable for	A and B clarinets
Height	444 mm
Number of legs	3 pieces

Order No.

black 15227-000-55

OBOE STAND

18020	
Weight	0.085 kg
Special features	detachable metal leg base screws into the peg so that the entire unit can be stored in the bell of the instrument
Material	plastic peg, zinc die-cast legs
Base diameter	255 mm
Leg construction	leg base screwable
Height	175 mm
Number of legs	4 pieces

Order No.

black 18020-000-55

FLUTE STAND

152/3	
Weight	0.12 kg
Material	wooden peg, plastic socket, steel legs
Leg construction	foldable legs
Suitable for	Bass, Böhm and Cross flutes
Height	165 mm
Number of legs	3 pieces
Peg diameter	18 mm

Order No.

nickel 15230-000-01

Even microphoned clarinets are easy to "park"



Folds compactly for ease of transport





FLUTE STAND

15232	
Weight	0.08 kg
Special features	the stand fits in almost every pocket when folded
Material	plastic peg, zinc die-cast legs
Leg construction	leg base screwable
Suitable for	Bass, Böhm and Cross flutes
Height	155 mm
Number of legs	4 pieces
Peg diameter	18 mm

Order No.

black 15232-000-55

Innovative and exceptionally light, this 4 leg flute stand 15232 is ideal for Boehm or transverse flutes. The plastic instrument holder has a diameter of 18 mm.

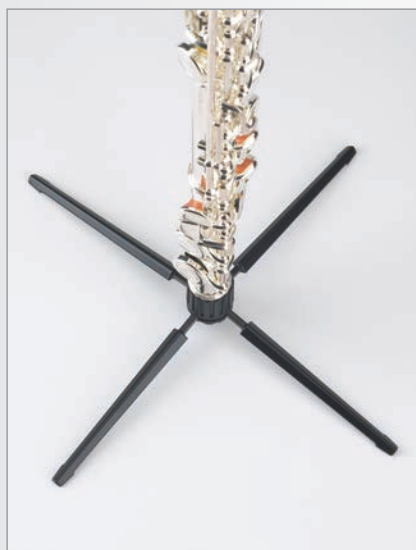

FLUTE STAND

152/5	
Weight	0.12 kg
Material	wooden peg, plastic socket, steel legs
Leg construction	foldable legs
Suitable for	alto and tenor flutes
Height	165 mm
Number of legs	3 pieces
Peg diameter	9.5 mm

Order No.

nickel 15250-000-01

FLUTE STAND

15252	
Weight	0.08 kg
Special features	the stand fits in almost every pocket when folded
Material	plastic peg with steel core, zinc die-cast legs
Leg construction	leg base screwable
Suitable for	alto and tenor flutes
Height	145 mm
Number of legs	4 pieces
Peg diameter	9 mm

Order No.

black 15252-000-55

FLUTE STAND

152/6	
Weight	0.1 kg
Material	wooden peg, plastic socket, steel legs
Leg construction	foldable legs
Suitable for	soprano and piccolo flutes
Height	165 mm
Number of legs	3 pieces
Peg diameter	6.5 mm

Order No.

nickel 15260-000-01



FLUTE STAND

15262	
Weight	0.08 kg
Special features	the stand fits in almost every pocket when folded
Material	plastic peg with steel core, zinc die-cast legs
Leg construction	leg base screwable
Suitable for	soprano and piccolo flutes
Height	145 mm
Number of legs	4 pieces
Peg diameter	6.5 mm

Order No.

black 15262-000-55

FLUTE HOLDER

15235	
Weight	0.18 kg
Material	plastic peg
Suitable for	Bass, Böhm and Cross flutes
Peg diameter	18 mm
Screw-on to	tube diameter up to 30 mm
Height	170 mm

Order No.

black 15235-000-55

FLUTE HOLDER

15255	
Weight	0.16 kg
Material	plastic peg with steel core
Suitable for	alto and tenor flutes
Peg diameter	9 mm
Screw-on to	tube diameter up to 30 mm
Height	165 mm

Order No.

black 15255-000-55



FLUTE HOLDER

15265	
Weight	0.15 kg
Material	plastic peg with steel core
Suitable for	soprano and piccolo flutes
Peg diameter	6.5 mm
Screw-on to	tube diameter up to 30 mm
Height	165 mm

Order No.
black 15265-000-55

PAN PIPE HOLDER

15268	
Weight	0.46 kg
Material	steel
Suitable for	pan pipes
Screw-on to	tube diameter up to 30 mm
Height	140 mm

Order No.
black 15268-000-55

BASS TROMBONE STAND

149/1	
Weight	2.21 kg
Material	steel
Leg construction	socket with foldable legs
Instrument support	wood with felt pads
Height	from 650 to 1,140 mm
Rod combination	2-piece folding design

Order No.
black 14910-013-55



Flexible holder for all common pan pipes.
Variably adjustable.

TROMBONE STAND

149/9

Weight	1.45 kg
Material	steel
Leg construction	brace construction, folds compactly
Instrument support	non-marring rubber
Height	from 555 to 865 mm
Rod combination	2-piece folding design

Order No.

schwarz 14990-000-55

Accessories

Carrying case 10811

Page

44

TROMBONE STAND

14985

Weight	1.14 kg
Material	steel
Leg construction	socket with foldable legs
Instrument support	non-marring rubber
Height	from 600 to 970 mm
Rod combination	2-piece folding design

Order No.

black 14985-000-55

Accessories

Carrying case 10811

Page

44

TROMBONE STAND

15270

Weight	1 kg
Special features	folds small; space-saving transportation in the instrument bell
Material	steel
Leg construction	foldable legs
Instrument support	plastic peg with felt pads
Height	from 585 to 885 mm
Rod combination	2-piece folding design

Order No.

black 15270-000-55



Foldable and compact for space-saving transportation in the instrument bell

TENOR HORN STAND

149/2	
Weight	2 kg
Special features	with integrated mouth piece holder; one-piece item folds to a small size
Material	steel
Base diameter	720 mm
Leg construction	tube legs with cross braces
Instrument support	non-marring slip-proof pads
Suitable for	baritone, tenor horn in Bb and alto horn in Eb
Size when folded	545 x 180 x 115 mm
Height	from 620 to 1,050 mm
Rod combination	2-piece folding design

Order No.
black 14920-012-55

Accessories	Page
Carrying case 14922	85

CARRYING CASE

14922	
Weight	0.4 kg
Material	nylon
Dimensions	670 x 150 x 130 mm
Handle or carrying type	handle
Fastener	zip fastener
Fits	149/2

Order No.
14922-000-00

BARITONE STAND

14941	
Weight	2.167 kg
Special features	additional notch for instruments with ridge
Material	steel
Instrument support	non-marring plastic material
Suitable for	all baritone and tenor horn models
Height	from 310 to 415 mm
Support width	from 200 to 305 mm

Order No.
black 14941-000-55

Accessories	Page
Carrying case 14942	86



One-piece item folds to a small size

Adjustable support arms



TUBA STAND

14940	
Weight	2.36 kg
Special features	additional notch for instruments with ridge
Material	steel
Instrument support	non-marring plastic material
Suitable for	German and English tubas
Height	from 310 to 415 mm
Support width	from 275 to 455 mm

Order No.	
black	14940-000-55

Accessories	Page
Carrying case 14942	86

CARRYING CASE

14942	
Weight	0.18 kg
Material	nylon
Dimensions	350 x 110 x 110 mm
Handle or carrying type	shoulder strap
Fastener	zip fastener
Fits	14940, 14941, 50500

Order No.	
	14942-000-00

STAND FOR KINGSIZE TUBA

14945	
Weight	3.46 kg
Special features	additional notch for instruments with ridge
Material	steel
Instrument support	non-marring plastic material
Size when folded	450 mm
Height	from 380 to 440 mm
Support width	from 310 to 530 mm

Order No.	
black	14945-000-55

Accessories	Page
Carrying case 14303	72



Adjustable support arms

Adjustable support arms



TUBA PERFORMER STAND

14950	
Weight	2.03 kg
Special features	suitable for playing in an sitting position; with safety pin
Material	steel
Leg construction	brace construction, folds compactly
Instrument support	non-marring rubber
Suitable for	tuba models
Height	from 450 to 800 mm
Rod combination	2-piece folding design
Max. load capacity	25 kg

Order No.	
black	14950-000-55

Accessories	Page
Carrying case 10811	44

TUBA PERFORMER STAND

14951	
Weight	2.24 kg
Special features	suitable for playing in a upright position; with safety pin
Material	steel
Leg construction	brace construction, folds compactly
Instrument support	non-marring rubber
Suitable for	tuba models
Height	from 650 to 1,140 mm
Rod combination	2-piece folding design
Max. load capacity	25 kg

Order No.	
black	14951-000-55

Accessories	Page
Carrying case 10811	44

TUBA PERFORMER STAND FOR CHILDREN

14952	
Weight	1.7 kg
Material	steel
Leg construction	U-profile legs snap into socket
Instrument support	non-marring rubber
Suitable for	tuba models
Height	from 250 to 400 mm
Rod combination	2-piece folding design

Order No.	
black	14952-000-55

Accessories	Page
Carrying case 14303	72



**SOUSAPHONE STAND****149/3**

Weight	3.66 kg
Special features	adjustable end cap to stabilize the stand on uneven surfaces
Material	steel
Instrument support	non-marring rubber
Size when folded	390 x 225 x 645 mm
Height	550 mm
Support width	775 mm

Order No.

black 14930-011-55

TRUMPET STAND**152/1**

Weight	0.24 kg
Special features	detachable metal leg base screws into the peg so that the entire unit can be stored in the bell of the instrument; rubber-covered peg top
Material	plastic peg, zinc die-cast legs
Leg construction	leg base screwable
Instrument support	felt pads
Height	190 mm
Number of legs	3 pieces

Order No.

black 15210-000-55



Leg base screws into the peg. Can be stored in the bell of the instrument.



Rubber peg top to prevent damage





Leg base screws into the peg. Unit can be stored in the bell of the instrument.

Rubber peg top to prevent damage



TRUMPET STAND

15213

Weight	0.32 kg
Special features	very stable; detachable metal leg base screws into the peg so that the entire unit can be stored in the bell of the instrument; rubber-covered peg top
Material	plastic peg, zinc die-cast legs
Leg construction	leg base screwable
Instrument support	felt pads
Height	205 mm
Number of legs	5 pieces

Order No.

black 15213-000-55

Thanks to its patented 5 leg base, the 15213 has achieved world-wide recognition. It features an extremely stable leg construction and space-saving transport method in the bell of the trumpet. Its solid zinc die-cast legs screw into the base. Felt pads and the rubber-covered peg top protect the instrument from scratches.

**TRUMPET STAND****15217**

Weight	0.6 kg
Special features	suitable for microphoned trumpets; rubber-covered peg top
Material	plastic peg, steel
Base diameter	350 mm
Leg construction	square tube legs snap into socket
Instrument support	felt pads
Height	466 mm
Number of legs	3 pieces

Order No.

black 15217-000-55

TRUMPET HOLDER**157**

Weight	0.14 kg
Material	steel
Instrument support	non-marring plastic material
Screw-on to	tube diameter up to 30 mm

Order No.

black 15700-000-55

TRUMPET HOLDER**15715**

Weight	0.32 kg
Special features	rubber-covered peg top
Material	plastic peg
Instrument support	felt pads
Screw-on to	tube diameter up to 30 mm
Height	230 mm

Order No.

black 15715-000-55

Even microphoned trumpets are easy to "park"



Folds compactly for ease of transport

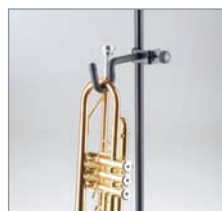

Rubber peg top to prevent damage



MUTE HOLDER

NEW

15910	
Weight	0.3 kg
Special features	for 3 mutes (2 x ø 80 mm, 1 x ø 60 mm); mute holder rings rubberized
Material	steel
Screw-on to	tube diameter up to 30 mm

Order No.
black 15910-000-55

Accessories	Page
Mute holder ring 15915	91

MUTE HOLDER RING

NEW

15915	
Weight	0.1 kg
Special features	Mute holder ring (ø 95 mm) rubberized
Material	steel
Fits	15910

Order No.
black 15915-000-55

TRUMPET WORK STATION

50500	
Weight	2.9 kg
Special features	table clamp included; for cleaning, maintaining and repairing; 360° rotatable; folds small
Material	steel
Suitable for	trumpet
Height	360 mm

Order No.
black 50500-000-55

Accessories	Page
Carrying case 14942	86



CLARINET PEG-SET

50510

Special features	practical supplement for the trumpet workstation 50500; set includes 2 clarinet pegs
Material	plastic
Suitable for	A and B clarinets
Threaded connector	M5

Order No.

black 50510-000-55

FLUGELHORN STAND

15240

Weight	0.42 kg
Special features	detachable metal leg base screws into the peg so that the entire unit can be stored in the bell of the instrument
Material	plastic peg, zinc die-cast legs
Leg construction	leg base screwable
Instrument support	felt pads
Height	250 mm
Number of legs	5 pieces

Order No.

black 15240-000-55

FRENCH HORN STAND

151/4

Weight	1.34 kg
Special features	adjustable side support; also for French shaped Eb horn and Parforcehorn; height adjustable
Material	wooden peg, steel legs
Base diameter	485 mm
Leg construction	foldable legs
Instrument support	felt pads
Height	282 mm
Number of legs	3 pieces

Order No.

black 15140-013-55



FOLDABLE BASE

17700	
Weight	0.16 kg
Material	steel
Accommodation of	1 instrument peg

Order No.

black	17700-005-55
-------	--------------

Accessories	Page
Clarinet peg 15224	94
Peg adapter 15281	95
English horn peg 17731	94
Oboe peg 17738	94
Clarinet peg 17741	94
Flute peg 17782	95
Flute peg 17786	95
Flute peg 17788	95

FOLDABLE BASE

17710	
Weight	0.54 kg
Material	steel
Accommodation of	4 instrument pegs

Order No.

black	17710-005-55
-------	--------------

Accessories	Page
Clarinet peg 15224	94
Peg adapter 15281	95
English horn peg 17731	94
Oboe peg 17738	94
Clarinet peg 17741	94
Flute peg 17782	95
Flute peg 17786	95
Flute peg 17788	95

BRACKET

12210	
Weight	0.115 kg
Special features	for the mounting of an array of different instrument pegs, trays and other accessories
Material	steel
Screw-on to	tube diameter 30 mm
Bore holes	diameter 5.2 mm (2 x)
Wall clearance	110 mm

Order No.

black	12210-000-55
-------	--------------

Accessories	Page
Clarinet peg 15224	94
Peg adapter 15281	95
English horn peg 17731	94
Oboe peg 17738	94
Clarinet peg 17741	94
Flute peg 17782	95
Flute peg 17786	95
Flute peg 17788	95



TRUMPET PEG

15214	
Weight	0.12 kg
Special features	rubber-covered peg top
Material	plastic
Instrument support	felt pads

Order No.

black	15214-000-55
-------	--------------

Accessories	Page
Peg adapter 15281	95

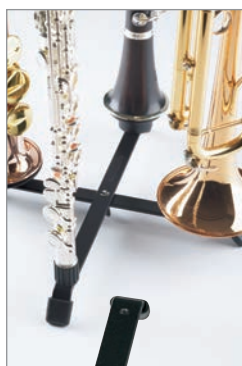

Rubber peg top to prevent damage

**CLARINET PEG****15224**

Weight	0.115 kg
Special features	peg adapter 15281 included; with felt ring
Material	plastic
Suitable for	A and B clarinets
Fits	12210, 17700, 17710

Order No.

black 15224-000-55

Accessories**Page**

Peg holder 14301

95

Felt
protective
ring**FLUGELHORN PEG****15244**

Weight	0.22 kg
Material	plastic
Instrument support	felt pads

Order No.

black 15244-000-55

Accessories**Page**

Peg adapter 15281

95

**SOPRANO SAXOPHONE PEG****15294**

Weight	0.1 kg
Material	plastic
Instrument support	felt pads

Order No.

black 15294-000-55

Accessories**Page**

Peg adapter 15281

95

**ENGLISH HORN PEG****17731**

Weight	0.088 kg
Material	wood
Instrument support	felt-lined
Threaded connector	M5
Fits	12210, 17700, 17710

Order No.

black 17731-005-55

Accessories**Page**

Peg holder 14301

95

**OBOE PEG****17738**

Weight	0.075 kg
Material	plastic
Height	170 mm
Threaded connector	M5
Fits	12210, 17700, 17710

Order No.

black 17738-005-55

Accessories**Page**

Peg holder 14301

95

**CLARINET PEG****17741**

Weight	0.08 kg
Material	wood
Instrument support	felt-lined
Suitable for	Eb- and C-clarinets
Threaded connector	M5
Fits	12210, 17700, 17710

Order No.

black 17741-005-55

Accessories**Page**

Peg holder 14301

95



FLUTE PEG

17782	
Weight	0.055 kg
Material	plastic peg with steel core
Suitable for	soprano and piccolo flutes
Peg diameter	6.5 mm
Threaded connector	M5
Fits	12210, 17700, 17710

Order No.	
black	17782-005-55

Accessories	Page
Peg holder 14301	95



FLUTE PEG

17786	
Weight	0.06 kg
Material	plastic peg with steel core
Suitable for	alto and tenor flutes
Peg diameter	9 mm
Threaded connector	M5
Fits	12210, 17700, 17710

Order No.	
black	17786-005-55

Accessories	Page
Peg holder 14301	95



FLUTE PEG

17788	
Weight	0.06 kg
Material	plastic
Suitable for	Bass, Böhm and Cross flutes
Peg diameter	18 mm
Threaded connector	M5
Fits	12210, 17700, 17710

Order No.	
black	17788-005-55

Accessories	Page
Peg holder 14301	95



PEG HOLDER

14301	
Weight	0.05 kg
Special features	includes 3 adaptors (for tubes ø 19 mm, ø 20 mm and oval form).
Material	plastic
Threaded connector	M5
Fits	14300, 14315, 15224, 17731, 17738, 17741, 17782, 17786, 17788

Order No.	
black	14301-000-55



PEG ADAPTER

15281	
Weight	0.084 kg
Material	plastic
Threaded connector	M5
Fits	12210, 15214, 15244, 15294, 17700, 17710

Order No.	
black	15281-005-55



ACCORDION STAND

174

Weight	7.05 kg
Special features	upper section swivels with both horizontal and vertical adjustment; replaceable rubber instrument protectors; additional levelling screw for uneven surfaces
Material	steel
Height adjustment	spring-loaded clamping knob
Instrument support	non-marring slip-proof pads
Height	from 730 to 1,135 mm
Support width	from 135 to 250 mm
Support height	from 380 to 585 mm
Base dimensions	660 x 660 mm

Order No.

black 17400-009-55



HARMONICA HOLDER

164/1

Weight	0.23 kg
Material	steel
Neck frame	with a soft rubber cover
Clamping	spring-tension
Max. instrument size	185 x 49 mm

Order No.

nickel-colored 16410-000-11



HARMONICA HOLDER

16415

Weight	0.25 kg
Special features	user-friendly locking screws
Material	steel
Neck frame	with a soft rubber cover
Clamping	spring-tension
Max. instrument size	185 x 49 mm

Order No.

black 16415-000-55



HARMONICA HOLDER

16416

Weight	0.26 kg
Special features	user-friendly locking screws; molded rubber sections on the support arms; particularly suitable for blues harmonica models with 108 mm max. instrument breadth
Material	steel
Neck frame	with a soft rubber cover
Clamping	spring-tension
Max. instrument size	185 x 43 mm

Order No.

black 16416-000-55





BASS DRUM STAND

133/3

Weight	2.66 kg
Material	steel
Instrument support	silicone cover
Support width	from 370 to 610 mm
Support depth	480 mm

Order No.

nickel 13330-000-01

TRIANGLE HOLDER

164/2

Weight	0.12 kg
Material	steel
Screw-on to	tube diameter up to 30 mm

Order No.

black 16420-000-55



PIANO TUNING LEVER

166

Weight	0.2 kg
Material	steel
Tuning lever shape	conical star
Tuning lever size	6.2 mm

Order No.

nickel 16600-000-01

PIANO TUNING LEVER

166/1

Weight	0.2 kg
Material	steel
Tuning lever shape	square
Tuning lever size	6.2 mm

Order No.

nickel 16610-000-01

PIANO TUNING LEVER SET

167

Weight	0.02 kg
Special features	Set includes 3 adapters
Material	steel
Tuning lever shape	conical star and square
Tuning lever size	star (5.8 mm); star (6.2 mm); square (6.2 mm)

Order No.

nickel 16700-000-01



TUNING FORK

168

Weight	0.02 kg
Special features	round design
Material	steel
Diameter	3.6 mm
Tuning	A 440 Hz
Length	105 mm

Order No.

nickel 16800-000-01

TUNING FORK

168/1

Weight	0.04 kg
Special features	round design
Material	steel
Diameter	4.5 mm
Tuning	A 440 Hz
Length	120 mm

Order No.

nickel 16810-000-01

TUNING FORK

168/2

Weight	0.04 kg
Special features	rectangular design
Material	steel
Tuning	A 440 Hz
Dimensions fork	4 x 6 mm
Length	120 mm

Order No.

nickel 16820-000-01



K&M KÖNIG & MEYER
Stands For Music



DRUMMER'S THRONES, BENCHES & STOOLS

A perfect drummer's throne and the proper posture it promotes is one of the most important requirements for a drummer.

Long testing phases and intensive collaboration with professional drummers like Mike "Gomezz" Gommeringer, Toni Liota and Sven "Ice" Ehrhardt have helped us to design our latest drummer's throne models to withstand the most stringent demands. Ergonomically perfect seats and an ingenious, finely-calibrated adjustability make the musician feel right at home on a König & Meyer drummer's throne.

Thanks to the usual high-quality workmanship and extensibility, König & Meyer keyboard benches and stools have long been classics among our customers.





DRUMMER'S THRONE »PICCOLINO«

14010	BASELINE
Weight	2.6 kg
Special features	small footprint with a diameter of 430 mm makes the throne ideal when space is at a premium; the easy-to-use wing nut permits a seat rotation
Material	steel
Base diameter	430 mm
Leg construction	double-braced 3-leg base
Height adjustment	push-button and clamping lever, in 15 mm steps
Rod combination	2-piece folding design
Seat	imitation leather, ø 300 mm
Height	from 363 to 453 mm

Order No.

chrome 14010-000-02

DRUMMER'S THRONE »PICCO«

14020	BASELINE
Weight	3.5 kg
Special features	small footprint with a diameter of 540 mm makes the throne ideal when space is at a premium; the easy-to-use wing nut permits a seat rotation
Material	steel
Base diameter	540 mm
Leg construction	double-braced 3-leg base
Height adjustment	push-button and clamping lever, in 15 mm steps
Rod combination	2-piece folding design
Seat	imitation leather, ø 300 mm
Height	from 481 to 661 mm

Order No.

chrome 14020-000-02

DRUMMER'S THRONE »GRANDE«

14030	TOPLINE
Weight	4.86 kg
Special features	robust rubber end caps; height adjustment by a notched system; the easy-to-use wing nut permits a seat rotation from loose to fixed position
Material	steel
Base diameter	625 mm
Leg construction	stable double-braced 3-leg base
Height adjustment	pull-button and clamping lever, in 10 mm steps
Rod combination	2-piece folding design
Seat	imitation leather, ø 330 mm
Height	from 490 to 690 mm

Order No.

chrome 14030-000-02

The smallest drum throne in the K&M series - excellently suitable for children.

For the beginner and advanced player too

The all rounder - compact with an excellent stability



Clamp with a patented push-button system



p15e.k-m.de
Product video



Height adjustment by a notched system

DRUMMER'S THRONE

14015/14016	TOPLINE
Weight	5.685 kg
Material	steel
Leg construction	double-braced 3-leg base
Height adjustment	spring-loaded bolt and locking screw
Rod combination	2-piece folding design
Seat	imitation leather or fabric covering, diameter 325 mm
Height	from 500 to 710 mm

Order No.

black leather	14015-000-55
black fabric	14016-000-55

Accessories

	Page
Backrest 14042/14043	111
Footrest 14051	111

DRUMMER'S THRONE »NICK«

14055/14056	TOPLINE
Weight	5.3 kg
Material	steel
Leg construction	double-braced 3-leg base
Height adjustment	spring-loaded bolt and locking screw
Rod combination	2-piece folding design
Seat	ergonomic seat, imitation leather or fabric covering, size 380 x 350 mm
Height	from 480 to 740 mm

Order No.

black leather	14055-000-55
black fabric	14056-000-55

Accessories

	Page
Backrest 14042/14043	111
Footrest 14051	111





The professional drummer's throne. Stable and sturdy.



p04e.k-m.de
Product video

Easy-to-use height adjustment

Sophisticated upholstery ergonomic seat



DRUMMER'S THRONE »GOMEZZ«

14000	STARLINE
Weight	6.04 kg
Special features	fixed large rubber end caps; height adjustment by a notched system; upper clamping lever permits a seat rotation from loose to fixed position; 4 threaded screw sockets to attach a ButtKicker
Material	steel
Leg construction	stable double-braced 3-leg base
Height adjustment	pull-button and clamping lever, in 10 mm steps
Rod combination	2-piece folding design
Seat	ergonomic seat, high quality grained soft nappa imitation leather, size 410 x 400 mm
Height	from 455 to 655 mm

Order No.

chrome 14000-000-02

The ergonomically designed seat with a sturdy artificial leather cover in classic leather grain reduces pressure on thighs creating an unique comfortable seat. Height adjustment by a notched system with 10 mm steps and an easy-to-use clamping lever. The extremely robust base design with extravagant foot end caps provides an unbelievably safe floor grip.

Accessories

Accessories	Page
Holder with tuning key 14001	110
Spike set 14002	110
Carrying case 14003	111





DRUMMER'S THRONE

14007	STARLINE
Weight	6.49 kg
Special features	fixed large rubber end caps; height adjustment by a notched system; upper clamping lever permits a seat rotation from loose to fixed position
Material	steel
Leg construction	stable double-braced 3-leg base
Height adjustment	pull-button and clamping lever, in 10 mm steps
Rod combination	2-piece folding design
Seat	high quality grained soft nappa imitation leather, diameter 380 mm
Height	from 510 to 710 mm

Order No.

chrome 14007-000-02

Professional drummer's throne: stable, foldable 3-leg base with fixed large rubber end caps for good floor contact and shock absorption. Extremely comfortable deluxe cushioned seat diameter 380 mm covered with high quality black soft nappa imitation leather with classic graining.

Easy-to-use height adjustment

Sophisticated upholstery ergonomic seat



Accessories

	Page
Holder with tuning key 14001	110
Spike set 14002	110





STOOL

14044/14045

Weight	6.17 kg
Special features	seat can be adjusted in height and angle; includes a height adjustable footrest; adjustable end cap to stabilize the stool on uneven surfaces
Material	steel
Height adjustment	spring-loaded clamping knob
Rod combination	2-piece folding design
Seat	ergonomic seat, imitation leather or fabric covering, size 380 x 350 mm
Height	from 600 to 900 mm

Order No.

black fabric	14044-000-55
black leather	14045-000-55

Accessories

Page

Backrest 14042/14043	111
Carrying case 14041	112





Height adjustment with **pneumatic spring** (10 kg press capacity)

Adjustable clamping lever



Folds flat



p07e.k-m.de
Product video

PNEUMATIC STOOL

14046/14047

Weight	8.37 kg
Special features	seat can be adjusted in height and angle; includes a pneumatic spring with 10 kg press capacity; includes a height adjustable footrest; adjustable end cap to stabilize the stool on uneven surfaces
Material	steel
Height adjustment	spring-loaded clamping knob/pneumatic spring
Rod combination	2-piece folding design
Seat	ergonomic seat, imitation leather or fabric covering, size 380 x 350 mm
Height	from 600 to 900 mm

Order No.

black fabric	14046-000-55
black leather	14047-000-55

The stool with power! The popular and functional stool 14044/14045 has been upgraded again. The secret lies in the integrated pneumatic spring for effortless and comfortable height adjustment. Simply release the clamping knob and it couldn't be easier to adjust the height.

Accessories

Accessories	Page
Backrest 14042/14043	111
Carrying case 14041	112





STOOL

14052/14053

Weight	5.65 kg
Material	steel
Leg construction	U-profile 3-leg base
Height adjustment	spring-loaded bolt and locking screw
Rod combination	2-piece folding design
Seat	ergonomic seat, imitation leather or fabric covering, size 380 x 350 mm
Height	from 560 to 930 mm

Order No.

black leather	14052-000-55
black fabric	14053-000-55

Accessories

Page

Backrest 14042/14043	111
Footrest 14051	111





STAGE STOOL

14091	
Weight	10 kg
Special features	height adjustable by built-in pneumatic spring
Material	steel
Base diameter	500 mm
Leg construction	round cast-iron base
Height adjustment	pneumatic spring
Rod combination	2-piece folding design
Seat	ergonomic seat, high quality grained soft nappa imitation leather, size 410 x 400 mm
Height	from 590 to 840 mm

Order No.

schwarz 14091-000-55

Perfect Appearance! The comfortable stage stool is not only easy on the eyes, its ergonomic saddle seat convinces through its extraordinary seating comfort. The height adjustable foot rest is in the form of a ring. The large circular base with the rubber ring provides reliable stability. The height of the stage stool is easily adjusted from 590 to 840 mm with the help of the integrated pneumatic spring.



DRUM STICK HOLDER

NEW

16450

Weight	0.22 kg
Material	steel
Dimensions	250 x 211 x 115 mm
Screw-on to	tube diameter up to 30 mm

Order No.

black 16450-000-55



The large quiver provides enough room for several drum stick sets



HOLDER WITH TUNING KEY

14001

Weight	0.06 kg
Special features	Spax screws and standard (square) tuning key included; SONOR special key (for square head bolts with slot) may be fitted additionally
Material	plastic
Dimensions	79 x 72 x 11.5 mm
Fits	14000, 14007

Order No.

14001-000-00



SPIKE SET

14002

Weight	0.1 kg
Special features	spikes are inserted into the rubber end caps; if required, the existing Allen screws can be replaced by the spikes; set consists of 3 spikes, 1 Allen key (to remove Allen screw) and 1 ring key (to fix spikes)
Material	steel
Length	21 mm
Fits	14000, 14007

Order No.

14002-000-00



CARRYING CASE

14003	
Weight	0.9 kg
Special features	internal compartments separate base from the seat
Material	nylon
Handle or carrying type	handle and shoulder straps
Fastener	zip fastener
Dimensions	550 x 540 x 130 mm
Fits	14000

Order No.
 14003-000-00

BACKREST

14042/14043	
Weight	2.12 kg
Special features	adjustable in height and depth
Material	steel
Height	465 mm
Back cushion	imitation leather or fabric covering, oval 240 x 390 mm
Fits	14015/14016, 14044/14045, 14046/14047, 14052/14053, 14055/14056

Order No.
 black leather 14042-000-55
 black fabric 14043-000-55

FOOTREST

14051	
Weight	1.07 kg
Special features	collapsible footrest
Material	steel
Dimensions	214 x 370 x 30 mm
Fits	14015/14016, 14052/14053, 14055/14056

Order No.
 black 14051-000-55





CARRYING CASE

14041

Weight	1.78 kg
Special features	reinforced outer shell to protect the stands
Material	nylon
Handle or carrying type	handle and shoulder straps
Fastener	zip fastener
Dimensions	930 x 400 x 150 mm
Fits	14044/14045, 14046/14047

Order No.

14041-000-00

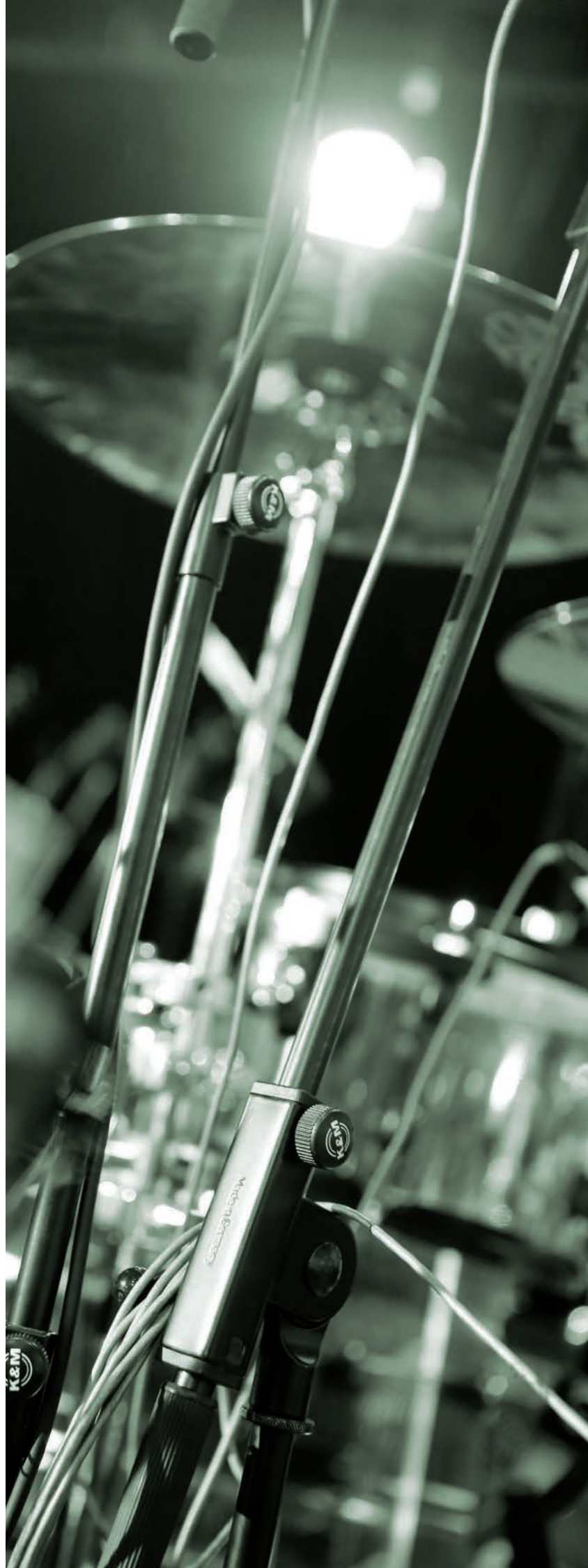

KEYBOARD BENCH

14065/14066	
Weight	5.18 kg
Special features	adjustable end cap to stabilize the bench on uneven surfaces; collapsible for easy transport
Material	steel
Height adjustment	inserted screw
Seat	imitation leather or fabric covering, size 540 x 300 mm
Height	from 395 to 585 mm

Order No.

black leather	14065-000-55
black fabric	14066-000-55

Accessories **Page**

Carrying case 14068	113
---------------------	-----

KEYBOARD BENCH

14075/14076	
Weight	6.37 kg
Special features	adjustable end cap to stabilize the bench on uneven surfaces; large seat; collapsible for easy transport
Material	steel
Height adjustment	inserted screw
Seat	imitation leather or fabric covering, size 650 x 300 mm
Height	from 405 to 605 mm

Order No.

black leather	14075-000-55
black fabric	14076-000-55

Accessories **Page**

Carrying case 14068	113
---------------------	-----

CARRYING CASE

14068	
Weight	0.96 kg
Material	nylon
Handle or carrying type	handle and shoulder straps
Fastener	zip fastener
Dimensions	790 x 340 x 130 mm
Fits	14065/14066, 14075/14076

Order No.

14068-000-00



Adjustable end cap

PIANO BENCH

14085/14086

Weight	9.36 kg
Special features	with engraved height scale
Material	steel
Height adjustment	spring-loaded clamping knob
Seat	imitation leather or fabric covering, size 660 x 330 mm
Height	from 430 to 670 mm

Order No.

black leather	14085-000-55
black fabric	14086-000-55

PIANO BENCH »UPLIFT«

14080/14081

Weight	11.58 kg
Special features	height adjustable by built-in pneumatic springs; easy-to-use adjustment handle
Material	steel
Height adjustment	pneumatic spring
Seat	imitation leather or fabric covering, size 660 x 330 mm
Size when folded	660 x 380 x 455 mm
Height	from 450 to 610 mm
Base dimensions	660 x 370 mm

Order No.

black leather	14080-000-55
black fabric	14081-000-55

PIANO BENCH

13900-13911

Weight	8.74 kg
Material	wood
Height adjustment	dual crossbar
Seat	velvet or imitation leather covering, size 550 x 330 mm
Height	from 460 to 550 mm

Order No.

bench black matt finish, seat black velvet	13900-100-20
bench black glossy finish, seat black velvet	13901-100-21
bench black matt finish, seat black imitation leather	13910-200-20
bench black glossy finish, seat black imitation leather	13911-200-21



Continuous height adjustment



p14e.k-m.de
Product video



PIANO BENCH - WOODEN-FRAME

13700-13751

Weight	7.2 kg
Material	wood
Height adjustment	dual crossbar
Height	from 460 to 550 mm

Order No.

black matt finish	13700-000-20
black glossy finish	13701-000-21
white matt finish	13710-000-22
white glossy finish	13711-000-23
rosewood matt finish	13720-000-24
walnut matt finish	13730-000-26
cherry matt finish	13740-000-28
mahogany glossy finish	13751-000-31



Piano bench wooden-frames in different colors for individual combination with K&M seat cushions.

Piano bench wooden-frame in different colors.

Solid European beech wood, varnished with four coats of polyester. Stable legs with non-slip rubber end-caps. Dual crossbar mechanism for easy and precise height adjustment. The piano bench ships flat and is easy to assemble.

Dual crossbar mechanism



Sample of piano bench wooden frame in combination with seat cushion.



Accessories

Page

Seat cushion - velvet 13800-13803	116
Seat cushion - imitation leather 13820-13824	117
Seat cushion - leather 13840/13841	117





Seat cushions in different colors for an individual combination with K&M piano bench wooden frames.



Sample of seat cushion in combination with piano bench.

SEAT CUSHION - VELVET

13800-13803	
Weight	1.46 kg
Material	velvet
Seat	velvet covering, size 550 x 330 mm
Fits	13700-13751

Order No.

black	13800-100-00
brown	13801-101-00
red	13802-102-00
hazelnut	13803-103-00

Seat cushions for piano benches 13700 through 13751. Heavy duty seat cushions made out of MDF material. Wide range of different colored velvet covers. The seat cushion is simply placed in the wooden frame of the piano bench. Any time you wish - or according to wear and tear - a replacement cushion can be ordered. Replacing the old cushion is very simple.

SEAT CUSHION - IMITATION LEATHER

13820-13824	
Weight	1.57 kg
Material	imitation leather
Seat	imitation leather covering, size 550 x 330 mm
Fits	13700-13751

Order No.

black	13820-200-00
brown	13821-201-00
white	13824-204-00

SEAT CUSHION - LEATHER

13840/13841	
Weight	1.48 kg
Material	leather
Seat	leather covering, size 550 x 330 mm
Fits	13700-13751

Order No.

black	13840-400-00
brown	13841-401-00

PIANO BENCH WITH SHEET MUSIC STORAGE

13950/13951	
Weight	10.6 kg
Material	wood
Height adjustment	dual crossbar
Seat	velvet or imitation leather covering, size 550 x 320 mm
Height	from 460 to 550 mm

Order No.

bench black glossy finish, seat black velvet	13950-100-21
bench black glossy finish, seat black imitation leather	13951-200-21

Seat cushions in different colors for an individual combination with K&M piano bench wooden frames.

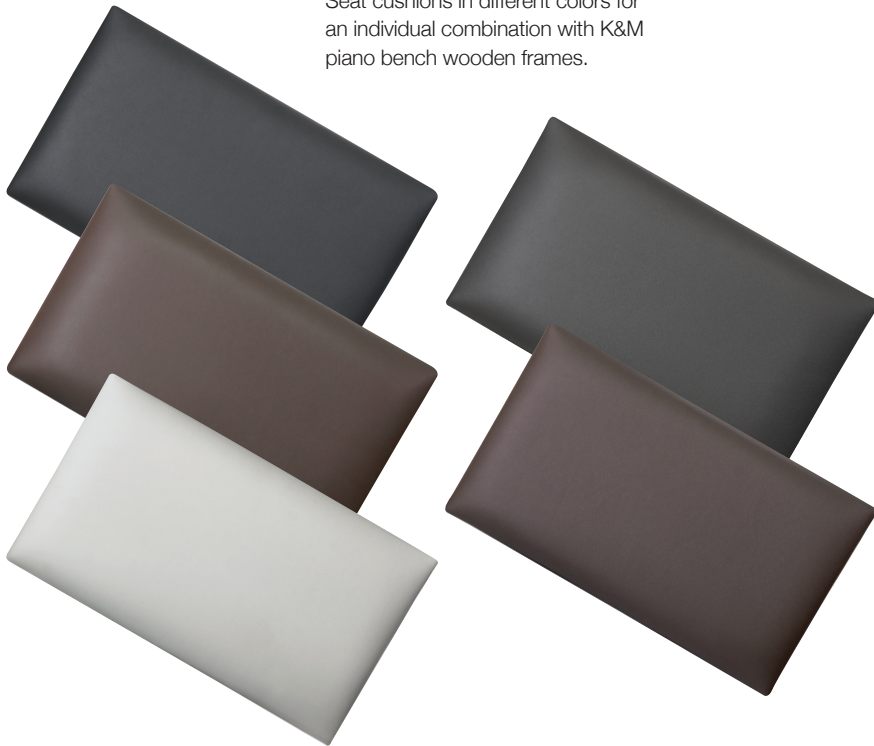

Solid European beech wood, varnished with four coats of black glossy polyester finish.



Sample of seat cushion in combination with piano bench.



With integrated sheet music storage.



**PIANO BENCH
WITH QUILTED SEAT CUSHION**

13980/13981

Weight	9.27 kg
Material	wood
Height adjustment	dual crossbar
Seat	leather or imitation leather covering, size 550 x 330 mm
Height	from 480 to 550 mm

Order No.

bench black glossy finish, seat black imitation leather	13980-200-21
bench black glossy finish, seat black leather	13981-400-21



With high quality quilted seat.

Solid European beech wood,
varnished with four coats of black
glossy polyester finish.



PIANO STOOL

14092	
Weight	6.31 kg
Material	steel
Base diameter	400 mm
Leg construction	round base
Height adjustment	pneumatic spring
Rod combination	2-piece folding design
Seat	imitation leather, ø 350 mm
Height	from 470 to 600 mm

Order No.

black 14092-000-55

PIANO STOOL

14093	
Weight	8.14 kg
Material	steel
Base diameter	400 mm
Leg construction	round base
Height adjustment	pneumatic spring
Rod combination	2-piece folding design
Seat	imitation leather, 430 x 330 mm
Height	from 470 to 600 mm

Order No.

black 14093-000-55



Continuous height adjustment



K&M KÖNIG & MEYER
Stands For Music





KEYBOARD STANDS

From experience, we know that among musicians, keyboardists often subject their stands to the most rigorous treatment.

When developing new stands for keyboard instruments, König & Meyer engineers and designers therefore pay extra special attention to the sometimes enormous weight of the instruments, the overview of the instrument needed while playing and the equally important ergonomic comfort of the keyboardist's "workplace". With painstaking attention to detail, König & Meyer imbue their keyboard stands with individualised adjustability, compactness for optimal transportability, and above all, reliability – gig after gig.



KEYBOARD STAND

18962	BASELINE
Weight	3.272 kg
Special features	additional locking positions on main X-tubes for extremely low level usage; adjustable end cap to stabilize the stand on uneven surfaces
Material	steel
Shape	X-stand
Max. load capacity	50 kg
Adjustment	two cross braces with inserted screw
Support width	from 440 to 770 mm
Support depth	350 mm
Height	from 400 to 905 mm

Order No.

black 18962-071-55

KEYBOARD STAND

18963	BASELINE
Weight	5.08 kg
Special features	for large keyboards; additional locking positions on main X-tubes for extremely low level usage; adjustable end cap to stabilize the stand on uneven surfaces
Material	steel
Shape	double-braced x-stand
Max. load capacity	50 kg
Adjustment	two cross braces with inserted screw
Support width	from 470 to 760 mm
Support depth	350 mm
Height	from 400 to 905 mm

Order No.

black 18963-071-55

KEYBOARD STAND FOR KIDS

18969	BASELINE
Weight	2.97 kg
Special features	additional locking positions on main X-tubes for extremely low level usage; slidable non-marring pads on the support arms provide a firm fit also for smaller keyboards; adjustable end cap to stabilize the stand on uneven surfaces
Material	steel
Shape	X-stand
Max. load capacity	50 kg
Adjustment	two cross braces with inserted screw
Support width	from 390 to 655 mm
Support depth	350 mm
Height	from 340 to 750 mm

Order No.

black 18969-071-55





KEYBOARD STAND

18930	TOPLINE
Weight	2.97 kg
Special features	Adjustable end cap to stabilize the stand on uneven surfaces
Material	steel
Shape	X-stand
Max. load capacity	50 kg
Adjustment	clamping lever for quick release
Support width	from 327 to 789 mm
Support depth	350 mm
Size when folded	1,020 x 102 x 520 mm
Height	from 594 to 964 mm
Instrument support	non-marring slip-proof pads

Order No.

black 18930-070-55

The ergonomic clamping mechanism makes setup or break down easy and fast. The robust metal joint can be adjusted in 5° intervals; the short intervals provide the user with a multitude of positions. With the assistance of a scale the user is able to easily find his preferred setting. Both of the back rubber end caps can be adjusted on their axis and as such can be adjusted perfectly to the width of the keyboard. The maximum support depth is 350 mm.

Clamping lever for quick release



Adjustable rubber pads

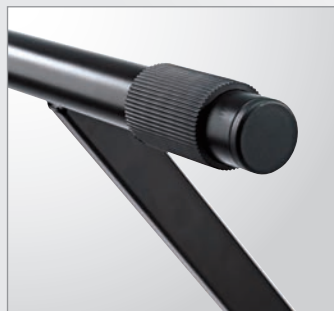

Accessories

Stacker 18941

Page

124



KEYBOARD STAND

18933	TOPLINE
Weight	3.77 kg
Special features	adjustable end cap to stabilize the stand on uneven surfaces; suitable for stage pianos
Material	steel
Shape	X-stand
Max. load capacity	50 kg
Adjustment	clamping lever for quick release
Support width	from 327 to 789 mm
Support depth	250 mm
Size when folded	1,020 x 102 x 520 mm
Height	from 594 to 946 mm
Instrument support	non-marring slip-proof pads

Order No.

black 18933-070-55

STACKER

18941	TOPLINE
Weight	2.046 kg
Special features	adjustable in height, depth and tilt
Material	steel
Max. load capacity	20 kg
Adjustment	tooth system with wing nut
Support depth	340 mm
Height	290 mm
Instrument support	big non-marring slip-proof pads and stop pins
Fits	18930, 18990

Order No.

black 18941-000-55





Adjustable end cap

Clamping lever for quick release



Adjustable rubber pads



KEYBOARD STAND »RICK«

NEW

18990	TOPLINE
Weight	5.8 kg
Special features	Adjustable end cap to stabilize the stand on uneven surfaces
Material	steel
Shape	double-braced x-stand
Max. load capacity	50 kg
Adjustment	clamping lever for quick release
Support width	from 327 to 789 mm
Support depth	350 mm
Height	from 594 to 946 mm
Instrument support	non-marring slip-proof pad

Order No.

black 18990-015-55

Our best X stand - comfortable and extremely sturdy. The new design of the double brace stand tubes provides for perceptible stability and safety. The ergonomic clamping lever makes it easy to setup and collapse the keyboard stand. The robust metal joint is intermeshed in 5° steps and provides for a multitude of different positions. The scale provides the user with the option to always select their preferred setting. Both of the back rubber end caps can be adjusted on their axis and as such can be adjusted perfectly to the width of the keyboard.

Accessories

Stacker 18941

Page

124



KEYBOARD STAND »RICK 20«

NEW

18993 **TOPLINE**

Weight	5.4 kg
Special features	adjustable end cap to stabilize the stand on uneven surfaces; with a minimum support arm depth for a perfect rest of stage pianos
Material	steel
Shape	double-braced x-stand
Max. load capacity	50 kg
Adjustment	clamping lever for quick release
Support width	from 327 to 789 mm
Support depth	250 mm
Height	from 594 to 946 mm
Instrument support	non-marring slip-proof pad

Order No.

black 18993-015-55



DISCOVER THE WORLD OF THE KEYBOARD STAND

18810 »OMEGA«

**19717
iPad Air 2
STAND HOLDER**
(Example)
Page 264



**18958
MUSIC HOLDER**
Page 134



**18956
BOOM ARM**
Page 134



**18813
STACKER**
Page 129



**18817
UNIVERSAL HOLDER**
Page 134



**18814
ADAPTER**
Page 129



**18815
LAPTOP HOLDER**
Page 129



**18810
KEYBOARD STAND »OMEGA«**
Page 128



p01e.k-m.de
Produktvideo

**TABLE-STYLE
KEYBOARD STAND »OMEGA«**

18810	TOPLINE
Weight	9.5 kg
Special features	with engraved height scale; includes 4 Velcro tapes to guide the cable
Material	steel
Shape	keyboard table
Height adjustment	spring-loaded clamping knob
Max. load capacity	50 kg
Support width	from 270 to 870 mm
Support depth	345 mm
Base dimensions	1,050 x 575 mm
Height	from 600 to 1,020 mm

Order No.

black 18810-015-55

Its compact steel tubing construction and large round floor protectors make this attractive keyboard table significantly more stable. Two sided spring-loaded locking screws make precision height adjustment easy. The support arms can be adjusted to suit the size of the keyboard. When folded, the table is impressively flat. The design of the table complements keyboard bench 14085 or 14086.

Folds flat



Accessories	Page
Stacker 18813	129
Adapter 18814	129
Laptop holder 18815	129
Universal holder 18817	134
Boom arm 18956	134
Music holder 18958	134



STACKER

18813	TOPLINE
Weight	3.94 kg
Special features	attachable to table-style keyboard stand »Omega« 18810 to hold an additional keyboard, laptop or midi controller; convenient height adjustment by spring-loaded locking knob; can be tilted in 5 different positions from 0° (horizontal) to 20°
Material	steel
Height adjustment	spring-loaded clamping knob
Max. load capacity	25 kg
Support depth	330 mm
Angle of inclination	0° to 20°
Height	from 200 to 300 mm
Instrument support	non-marring slip-proof pads
Fits	18810

Order No.
black 18813-011-55

ADAPTER

18814	TOPLINE
Weight	0.35 kg
Special features	additional adapter to attach boom arm 18956, music holder 18958, iPad holder 18816 or universal holder 18817 to table-style keyboard stand »Omega« 18810
Material	steel
Dimensions	240 x 30 x 20 mm
Fits	18810

Order No.
black 18814-000-55

Accessories	Page
Universal holder 18817	134
Boom arm 18956	134
Music holder 18958	134

LAPTOP HOLDER

18815	TOPLINE
Weight	1.88 kg
Special features	infinitely variable in height, direction, distance and tilt
Material	steel holder, aluminum shelf
Adjustment	tilt gradual in 8 settings
Size when folded	440 x 340 x 55 mm
Angle of inclination	0° to 30°
Height	310 mm
Fits	18810, 18950, 18953

Order No.
black 18815-000-55





EQUIPMENT STAND

18825	TOPLINE
Weight	6.012 kg
Special features	suitable for mixer, monitor, keyboard or amplifier; adjustable end cap to stabilize the stand on uneven surfaces
Material	steel
Shape	keyboard table
Max. load capacity	50 kg
Adjustment	interlocking braces
Support width	from 250 to 840 mm
Support depth	250 mm
Height	from 660 to 915 mm

Order No.

black	18825-000-55
-------	--------------

TABLE-STYLE KEYBOARD STAND

18880	TOPLINE
Weight	2.64 kg
Material	aluminum
Shape	keyboard table
Max. load capacity	50 kg
Adjustment	interlocking braces
Support width	700 mm
Support depth	400 mm
Height	from 630 to 960 mm

Order No.

black	18880-000-55
-------	--------------

Accessories

Accessories	Page
Stacker A 18881	130
Stacker B 18882	131

STACKER A

18881	TOPLINE
Weight	0.9 kg
Special features	attachable to keyboard stand 18880 to hold an additional keyboard; adjustable in tilt and height
Material	aluminum
Max. load capacity	25 kg
Support depth	340 mm
Height	from 200 to 370 mm
Instrument support	big non-marring slip-proof pads and stop pins
Fits	18880, 18882

Order No.

black	18881-000-55
-------	--------------



Versatile all-rounder stand with separately height adjustable support arms.

Folds flat



Fully collapsible

STACKER B

18882	TOPLINE
Weight	0.97 kg
Special features	in combination with stacker A for 3 keyboards; adjustable in depth, tilt and height
Material	aluminum
Max. load capacity	25 kg
Support depth	from 340 to 450 mm
Height	from 200 to 370 mm
Instrument support	big non-marring slip-proof pads and stop pins
Fits	18880

Order No.

black 18882-000-55

Accessories

Page

Stacker A 18881

130





TABLE-STYLE KEYBOARD STAND

18950	TOPLINE
Weight	9.3 kg
Special features	heavy-duty stand; individual height-adjustment for each leg; additional levelling screws for uneven surfaces
Material	steel
Shape	keyboard table
Max. load capacity	80 kg
Support width	from 650 to 1,030 mm
Support depth	395 mm
Height	from 670 to 910 mm
Instrument support	non-marring rubber

Order No.

black 18950-000-55

This highly versatile table-style keyboard stand leaves nothing more to be desired. Multiple points of adjustment and accessory options make the stand very adaptable. High-quality materials and quality craftsmanship are the mainstay of this indestructible keyboard table. A sophisticated folding mechanism means the table can be collapsed to an extraordinarily compact and portable unit.



Accessories	Page
Laptop holder 18815	129
Universal holder 18817	134
Stacker 18952	133
Adapter 18954	133
Boom arm 18956	134
Music holder 18958	134
Carrying case 18959	143



TABLE-STYLE STAGE PIANO STAND

18953	TOPLINE
Weight	7.88 kg
Special features	heavy-duty stand; individual height-adjustment for each leg; additional levelling screws for uneven surfaces
Material	steel
Shape	keyboard table
Max. load capacity	80 kg
Support width	900 mm
Support depth	260 mm
Height	from 610 to 860 mm

Order No.
black 18953-000-55

Accessories	Page
Laptop holder 18815	129
Universal holder 18817	134
Stacker 18952	133
Adapter 18954	133
Boom arm 18956	134
Music holder 18958	134
Carrying case 18955	143

For stage pianos, supports max. 80 kg



STACKER

18952	TOPLINE
Weight	2.3 kg
Special features	for second keyboard in combination with 18950 and 18953; adjustable in height, tilt and depth
Material	steel
Max. load capacity	30 kg
Support depth	340 mm
Height	from 265 to 390 mm
Instrument support	big non-marring slip-proof pads and stop pins
Fits	18950, 18953

Order No.
black 18952-000-55



ADAPTER

18954	TOPLINE
Weight	0.38 kg
Special features	additional adapter to attach boom arm 18956, music holder 18958, iPad holder 18816 or universal holder 18817 to keyboard/stage piano stand 18950 or 18953; only necessary, when stacker 18952 is installed
Material	steel
Dimensions	200 x 30 x 20 mm
Fits	18950, 18953

Order No.
black 18954-000-55



UNIVERSAL HOLDER

18817	TOPLINE
Weight	0.65 kg
Special features	attaches to keyboard/ stage piano stand 18950 or 18953 and also with adapter 18814 to table-style keyboard stand »Omega« 18810; connects other accessories, such as boom arm, gooseneck, iPad holder, Tablet PC holder etc.; incl. thread adapter 3/8" - 5/8"
Material	steel
Height	460 mm
Threaded connector	3/8"
Fits	18810, 18814, 18950, 18953

Order No.
black 18817-000-55

Accessories	Page
iPad stand holder 19712	263
iPad mini stand holder 19713	263
iPad Air stand holder 19714	263
iPad Air 2 stand holder 19717	264
Tablet PC stand holder 19742	264

BOOM ARM

18956	TOPLINE
Weight	1.29 kg
Special features	attaches to keyboard/ stage piano stand 18950 or 18953 and also with adapter 18814 to table-style keyboard stand »Omega« 18810; adjustable in height and tilt
Material	steel
Height adjustment	gradually in 8 settings
Height	from 225 to 520 mm
Boom arm	2-piece telescopic design
Boom arm clamping	wing nut
Boom arm length	from 425 to 725 mm
Fits	18810, 18814, 18950, 18953

Order No.
black 18956-300-55

MUSIC HOLDER

18958	TOPLINE
Weight	1.42 kg
Special features	attaches to keyboard/ stage piano stand 18950 or 18953 and also with adapter 18814 to table-style keyboard stand »Omega« 18810; adjustable in height and tilt
Material	steel
Height adjustment	gradually in 8 settings
Height	from 195 to 480 mm
Music desk dimensions	485 x 240 mm
Fits	18810, 18814, 18950, 18953

Order No.
black 18958-000-55



For the keyboard tables 18810 »Omega«, 18950 and 18953



KEYBOARD STAND »SPIDER«

18850	TOPLINE
Weight	9.55 kg
Special features	leg construction offers freedom of movement of the legs and gives room for pedals; can be used as display stands in stores; folds small
Material	aluminum
Shape	column stand
Height adjustment	infinitely variable by means of ergonomically shaped clamping elements
Max. load capacity per tier	35 kg
Max. load capacity	105 kg
Support arms	two pairs, non-telescopic
Support depth	280 mm
Height	1,410 mm

Order No.

anodized aluminum	18850-000-30
black anodized	18850-000-35

Accessories

	Page
Carrying case 18851	142
Adapter for »Spider« 18852	136
Support arm set 18855	136

ADAPTER FOR »SPIDER«

18852	TOPLINE
Weight	0.15 kg
Special features	for attaching microphone booms to the »Spider« keyboard stand
Material	plastic
Male thread	3/8" and 5/8"
Fits	18850

Order No.

black	18852-000-55
-------	--------------



SUPPORT ARM SET

18855	TOPLINE
Weight	0.63 kg
Special features	additional support arms with clamping element for keyboard stand »Spider«
Material	aluminum
Max. load capacity	35 kg
Support depth	280 mm
Fits	18850

Order No.

anodized aluminum	18855-000-30
black anodized	18855-000-35



DISCOVER THE WORLD OF THE KEYBOARD STAND

18860 »SPIDER PRO«

**21140
BOOM ARM**
(Example)

**18872
EXTENSION ROD**
Page 142

**19717
iPad Air 2-STAND HOLDER**
(Example)
Page 264

**18868
LAPTOP REST**
Page 140

**18874
SHEET
MUSIC
HOLDER**
Page 141

**18873
UNIVERSAL HOLDER**
Page 140

**18866
SUPPORT ARM SET B**
Page 139

**18865
SUPPORT ARM SET A**
Page 139

**18860
KEYBOARD STAND
»SPIDER PRO«**
Page 137



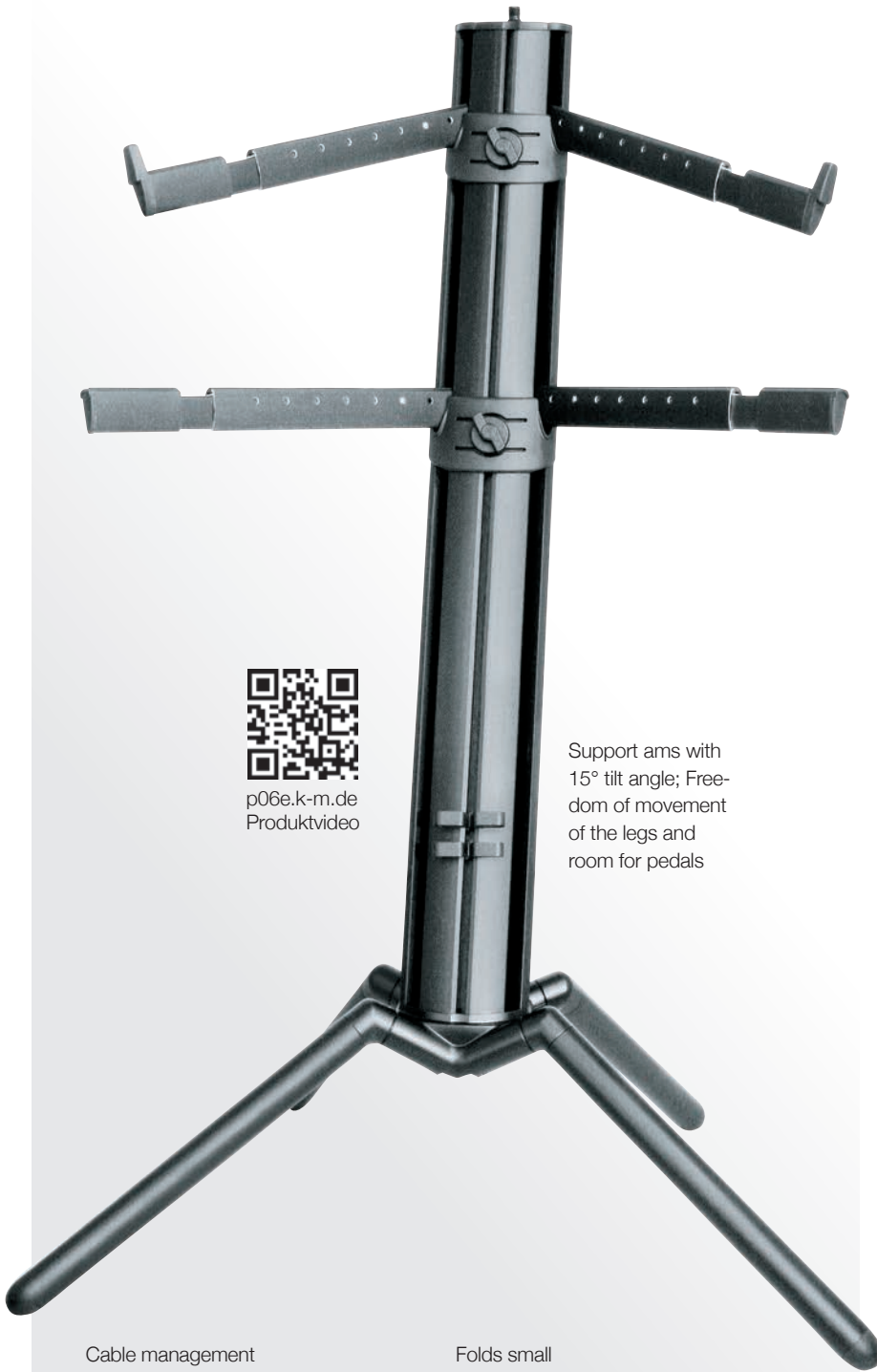

Support arms with 15° tilt angle; Freedom of movement of the legs and room for pedals

KEYBOARD STAND »SPIDER PRO«

18860	STARLINE
Weight	10.5 kg
Special features	with a 3/8" or 5/8" threaded connector for microphone boom; cable management; comfortable tilt of column; freedom of movement of the legs and room for pedals; folds small; gradual adjustment of the depth
Material	aluminum
Shape	column stand
Height adjustment	infinitely variable by means of ergonomically shaped clamping elements
Max. load capacity per tier	35 kg
Max. load capacity	105 kg
Support arms	two telescopic pairs, one pair with additional 15° tilt angle
Support width	from 670 to 940 mm
Support depth	from 300 to 470 mm
Height	1,310 mm

Order No.

anodized aluminum	18860-000-30
black anodized	18860-000-35

The innovatively designed, stylish and highly functional keyboard stand with a high-quality finish and well-thought-out construction is easy to collapse in a few movements and easy to transport... and consequently a favourite with professional musicians.

Cable management



Folds small



Accessories

	Page
Carrying case 18851	142
Support arm set A 18865	139
Support arm set B 18866	139
Universal holder 18873	140
Sheet music holder 18874	141
Laptop rest 18868	140
Adapter 18853	141
Threaded bolt set 18864	141
Extension rod 18872	142
Controller keyboard tray 18876	139
Lectern desk 18877	140



Freedom of movement of the legs and room for pedals

Cable management



Folds small



KEYBOARD STAND »BABY-SPIDER PRO«

18840 STARLINE

Weight	8.06 kg
Special features	with a 3/8" or 5/8" threaded connector for microphone boom; cable management; freedom of movement of the legs and gives room for pedals; folds small
Material	aluminum
Shape	column stand
Height adjustment	infinitely variable by means of ergonomically shaped clamping elements
Max. load capacity per tier	35 kg
Max. load capacity	70 kg
Support arms	one pair, telescopic
Support width	from 670 to 980 mm
Support depth	from 290 to 470 mm
Height	990 mm

Order No.

anodized aluminum	18840-000-30
black anodized	18840-000-35

Equipped with a pair of extendable support arms, a 3/8" or 5/8" threaded connector for the attachment of microphone booms and a cable clamp for cable management. The stand provides infinitely variable height adjustment and a gradually adjustment of the depth. The stand collapses easily in one piece. Maximum load per tier: 35 kg.

Accessories

Accessories	Page
Carrying case 18846	142
Support arm set A 18865	139
Support arm set B 18866	139
Universal holder 18873	140
Sheet music holder for 18874	141
Laptop rest 18868	140
Adapter for 18853	141
Threaded bolt set for 18864	141
Extension rod 18872	142

SUPPORT ARM SET A

18865	
Weight	0.95 kg
Special features	telescopic
Material	aluminum
Max. load capacity	35 kg
Support width	from 650 to 940 mm
Support depth	from 300 to 490 mm
Fits	18840, 18860

Order No.

anodized aluminum	18865-000-30
black anodized	18865-000-35

SUPPORT ARM SET B

18866	
Weight	0.94 kg
Special features	telescopic and 15° tilt angle
Material	aluminum
Support width	from 670 to 980 mm
Support depth	from 290 to 470 mm
Fits	18840, 18860

Order No.

anodized aluminum	18866-000-30
black anodized	18866-000-35

Accessories

Page

Controller keyboard tray 18876	139
Lectern desk 18877	140

CONTROLLER KEYBOARD TRAY

NEW

18876	
Weight	1 kg
Special features	to storage smaller synthesizers, controllers, drum machines etc; with integrated handle; 4 rubber pads included
Material	aluminum
Dimensions	640 x 326 x 25 mm
Fits	18860, 18866

Order No.

black	18876-000-55
-------	--------------



**LECTERN DESK
FOR THE »SPIDER PRO«**

NEW

18877

Weight	1 kg
Special features	space for two DIN A4 sheets; integrated edge protectors
Material	aluminum
Dimensions	638 x 325 x 14 mm
Fits	18860, 18866

Order No.

black 18877-000-55

LAPTOP REST

18868

Weight	1.3 kg
Special features	soft caps; 4 rubber pads included
Material	steel
Max. load capacity	8 kg
Adjustment	tilt gradual in 4 settings
Angle of inclination	0° to 25°
Dimensions	310 x 265 x 150 mm
Fits	18840, 18860

Order No.

black 18868-000-55
silver 18868-000-81

UNIVERSAL HOLDER FOR »SPIDER PRO«

18873

Weight	0.59 kg
Special features	continuously height adjustment; the threaded bolt connection expands the range of »Spider Pro« and »Baby Spider Pro« uses
Material	steel
Threaded connector	3/8"
Fits	18840, 18860

Order No.

schwarz 18873-300-55



Tiltable in 4 steps



SHEET MUSIC HOLDER FOR »SPIDER PRO«

18874	
Weight	1.3 kg
Special features	continuously height adjustment
Material	steel
Height adjustment	continuous
Music desk dimensions	480 x 240 x 42 mm
Fits	18840, 18860

Order No.

black 18874-000-55

ADAPTER FOR »SPIDER PRO«

18853	
Weight	0.14 kg
Special features	reinforcement to attach heavy booms and sheet music holders
Material	steel
Dimensions	136 x 85 x 29 mm
Fits	18840, 18860

Order No.

schwarz 18853-000-55

THREADED BOLT SET FOR »SPIDER PRO«

18864	
Weight	0.04 kg
Special features	only necessary when the »Spider Pro« is modified to take the laptop rest 18868; features: to mount microphone booms and music sheet desks to the »Spider Pro« products; long threaded bolt necessary when laptop rest 18868 is installed
Material	steel
Male thread	3/8" or rather M8
Fits	18840, 18860

Order No.

black zinc-plated 18864-000-25



For the »Spider Pro« models 18860 and 18840

EXTENSION ROD

18872

Weight	0.387 kg
Special features	in combination with threaded bolt set 18864 to mount microphone booms to the »Spider Pro« products when laptop rest 18868 is installed
Material	steel
Height adjustment	clutch
Height	from 330 to 550 mm
Threaded connector	3/8"
Rod combination	2-piece folding design
Fits	18840, 18860

Order No.

black 18872-300-55

CARRYING CASE

18846

Weight	0.7 kg
Material	nylon
Dimensions	880 x 180 x 185 mm
Handle or carrying type	handle
Fastener	zip fastener
Fits	14160, 14760, 14761, 15045, 17620, 18840, 21455

Order No.

18846-000-00

CARRYING CASE

18851

Weight	0.88 kg
Material	nylon
Dimensions	1,280 x 180 x 185 mm
Handle or carrying type	handle
Fastener	zip fastener
Fits	18850, 18860, 21338, 21339, 21340

Order No.

18851-000-00



CARRYING CASE

18955	
Weight	1.18 kg
Material	nylon
Dimensions	900 x 350 x 90 mm
Handle or carrying type	handle and shoulder straps
Fastener	zip fastener
Fits	18953

Order No.

18955-000-00

CARRYING CASE

18959	
Weight	1.68 kg
Material	nylon
Dimensions	1,150 x 550 x 100 mm
Handle or carrying type	handle and shoulder straps
Fastener	zip fastener
Fits	18950

Order No.

18959-000-00



K&M KÖNIG & MEYER
Stands For Music



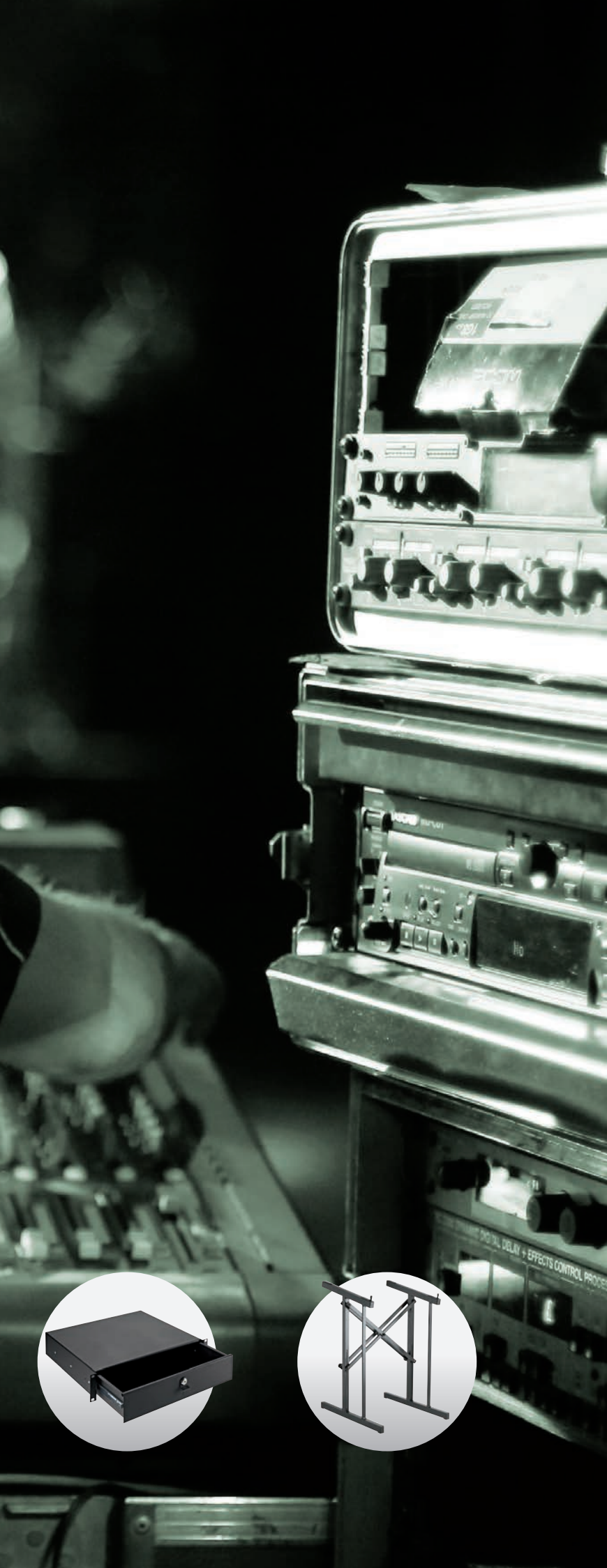

STANDS FOR MIXER, MONITORS, AND 19" RACK-MOUNTED PRODUCTS

Whether in the rehearsal room, on stage or in a professional sound studio, König & Meyer stands and racks also pull their weight in a discreet yet dependable way day after day. The high-quality, attractively designed 19" equipment is equally appropriate for use on stage as well as for everyday use in the studio.

A large selection of accessories guarantees flexibility for every purpose. The systems are extendable upon demand, practical and comfortable, and can also be adjusted to suit.





HEADPHONE HOLDER

16080

Weight	0.185 kg
Special features	for up to 2 standard headphones and 2 In-Ear headphones
Material	steel
Support width	100 mm
Support depth	60 mm
Size when folded	60 x 70 x 180 mm
Screw-on to	tube diameter up to 30 mm
Support	rubber covered

Order No.

black 16080-000-55

HEADPHONE HOLDER WITH TABLE CLAMP

16085

Weight	0.26 kg
Special features	for up to 2 standard headphones and 2 In-Ear headphones; the holder can be rotated from any position by 90°
Material	steel
Support width	100 mm
Support depth	60 mm
Clamping range	up to 53 mm
Support	rubber covered

Order No.

black 16085-000-55

HEADPHONE HOLDER

16090

Weight	0.205 kg
Special features	for up to 2 standard headphones and 2 In-Ear headphones
Material	steel
Support width	100 mm
Support depth	60 mm
Clamping range	up to 45 mm
Support	rubber covered

Order No.

black 16090-000-55



Can easily take two sets of headphones



Can easily take two sets of headphones.



HEADPHONE WALL HOLDER

16310	
Weight	0.22 kg
Special features	for up to 2 standard headphones and 2 In-Ear headphones
Material	steel
Support width	100 mm
Support depth	60 mm
Support	rubber covered

Order No.

black 16310-000-55

UNIVERSAL HOLDER

16320	
Weight	0.134 kg
Special features	swiveling
Material	steel
Size when folded	160 x 24 x 90 mm
Height	90 mm
Support	rubber covered

Order No.

black 16320-000-55



Can easily take two sets of headphones

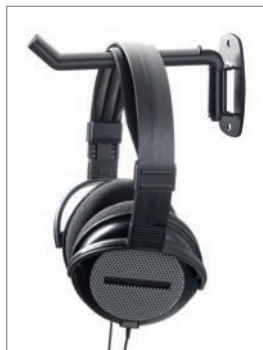



MIXER STAND

28075	
Weight	5.92 kg
Special features	additional levelling screw for uneven surfaces
Material	steel
Support	felt pads
Max. load capacity	35 kg
Adjustment	support arms gradual in 15° settings
Angle of inclination	0° to 45°
Suitable for	amplifiers and mixers
Height adjustment	spring-loaded clamping knob
Support width	from 455 to 665 mm
Support depth	310 mm
Height	from 710 to 1,005 mm
Leg construction	collapsible square tube legs
Number of legs	4 pieces

Order No.

black 28075-000-55

MONITOR STAND

28101	
Weight	3.66 kg
Material	steel
Max. load capacity	35 kg
Angle of inclination	42°
Suitable for	amplifiers or monitor speakers
Support width	280 mm
Support depth	350 mm
Height	from 425 to 515 mm
Leg construction	collapsible base

Order No.

black 28101-000-55



**AMP STAND****28130**

Weight	1.58 kg
Special features	with a 3/8" or 5/8" threaded connection for attaching a microphone boom; folds very small; support arms with non-marring rubber
Material	steel
Support	non-marring material
Max. load capacity	35 kg
Angle of inclination	15° to 28°
Suitable for	amplifiers, monitors and speakers
Support width	from 350 to 530 mm
Support depth	from 280 to 385 mm
Size when folded	122 x 86 x 602 mm
Height	from 570 to 990 mm
Leg construction	tube legs with cross braces
Number of legs	3 pieces

Order No.

black	28130-011-55
-------	--------------

The amp stand can hold monitors, amps or other equipment to a max. weight of 35 kg without a problem. The angled front legs have significantly improved the stand's stability and strength. The low centre of gravity ensures even larger amps are securely displayed. The fine adjustment on the supporting leg allows a tilt between 15° and 28°. A microphone can be attached to the telescopic tube using a boom arm with a thread of either 3/8" or 5/8". Folds compactly.

**Accessories**

Carrying case 10811	44
---------------------	----

Page



MIXER STAND

42040

Weight	2.6 kg
Material	aluminum
Support	non-marring rubber
Max. load capacity	40 kg
Adjustment	interlocking braces
Support width	525 mm
Support depth	480 mm
Height	725 mm

Order No.

black 42040-000-55



RACK WAGON

28200	
Weight	13.6 kg
Special features	four casters, two of them locking; Cage nuts M5 and locking screws M5 x 16 (30 pieces) are included
Material	steel
Height (units)	16 + 7 spaces
Height	1,060 mm

Order No.
black 28200-000-55

Accessories	Page
Side cover 28201	151

SIDE COVER

28201	
Weight	4.36 kg
Special features	contains 2 steel side covers with drillings and 14 screws M5 x 16 mm
Material	steel
Height	880 mm
Fits	28200

Order No.
black 28201-000-55

RACK DESK STAND

40900	
Weight	4.34 kg
Special features	Cage nuts M5 (16 pieces) and locking screws M5 x 16 are included
Material	steel
Height (units)	8 spaces
Base dimensions	440 x 550 mm

Order No.
black 40900-000-55





RACK WAGON

42020

Weight	12.88 kg
Special features	four casters, two of them locking; Cage nuts M5 and locking screws M5 x 16 (32 pieces) are included; angle adjustable to 45°; heavy-duty construction
Material	steel
Height (units)	12 spaces in top section, 9 spaces in lower section
Max. load capacity	50 kg
Adjustment	T-bar locking screw
Height	875 mm

Order No.

black 42020-000-55

Accessories

Page

Extender brackets 19" 42021 152

EXTENDER BRACKETS 19"

42021

Weight	2.14 kg
Special features	Cage nuts M5 and locking screws M5 x 16 (16 pieces) are included
Material	steel
Height (units)	9 spaces
Height	500 mm
Fits	42020

Order No.

black 42021-000-55

RACK

48240

Special features	rack rails on front and back side
Material	steel
Dimensions	525 x 429 mm

Order No.

black, 8 spaces, 9,92 kg 48240-008-55
black, 12 spaces, 10,0 kg 48240-012-55



RACK

48260	
Special features	rack rails on front and back side; sloped front; with casters
Material	steel

Order No.

black, 16 spaces, 16,32 kg	48260-016-55
black, 21 spaces, 18,56 kg	48260-021-55

**RACKSHELLY**

28480	
Weight	0.21 kg
Special features	two optional rackshellys
Material	steel
Suitable for	rack shelves no. 28482 and 28483
Fits	28481-28483

Order No.

black	28480-000-55
-------	--------------

**19" RACK SHELF**

28481-28483	
Special features	in 1, 2 and 3 spaces 300 mm or 380 mm deep
Material	steel

Order No.

black, 1 space, 300 mm, 1,84 kg	28481-000-55
black, 1 space, 380 mm, 2,37 kg	28481-070-55
black, 2 spaces, 300 mm, 2,14 kg	28482-000-55
black, 2 spaces, 380 mm, 2,79 kg	28482-070-55
black, 3 spaces, 300 mm, 2,5 kg	28483-000-55
black, 3 spaces, 380 mm, 3,13 kg	28483-070-55

Accessories

Rackshelly 28480

Page

153

**UNIVERSAL RACK SHELF**

49035	
Weight	1.502 kg
Special features	to mount half rack components, wireless units, and other gear horizontally
Material	steel
Height (units)	1 space
Depth	240 mm

Order No.

black	49035-000-55
-------	--------------

SLIDING SHELF

49070	
Weight	5.2 kg
Special features	security lock for uncontrolled reverse motion
Material	steel
Height (units)	1 space
Depth	360 mm

Order No.

black	49070-000-55
-------	--------------





RACKMOUNT LOCKBOX

49103

Special features	storage unit with key lock
Material	steel
Height (units)	3 spaces
Depth	225 mm

Order No.

black	49103-000-55
-------	--------------

PANEL

28210-28240

Special features	flat style
Material	aluminum
Thickness	2 mm

Order No.

black, 1 space, 0,12 kg	28210-070-55
black, 2 spaces, 0,24 kg	28220-070-55
black, 3 spaces, 0,36 kg	28230-070-55
black, 4 spaces, 0,48 kg	28240-070-55

PANEL

28306-28312

Material	steel
Height (units)	1 space
Suitable for	XLR connectors

Order No.

6 XLR, 0,28 kg	28306-000-55
8 XLR, 0,28 kg	28308-000-55
12 XLR, 0,24 kg	28312-000-55



VENTILATION PANEL

28451/28452

Special features	with ventilation slots
Material	steel

Order No.

black, 1 space, 0,26 kg	28451-000-55
black, 2 spaces, 0,46 kg	28452-000-55

PANEL

494/1

Special features	flanged style
Material	steel
Thickness	1.5 mm

Order No.

black, 1 space, 0,28 kg	49411-000-55
black, 2 spaces, 0,48 kg	49412-000-55
black, 3 spaces, 0,7 kg	49413-000-55
black, 4 spaces, 0,94 kg	49414-000-55

PANEL

494/2

Special features	flanged style
Material	aluminum
Thickness	1.5 mm

Order No.

black, 1 space, 0,1 kg	49421-000-55
black, 2 spaces, 0,2 kg	49422-000-55
black, 3 spaces, 0,32 kg	49423-000-55
black, 4 spaces, 0,4 kg	49424-000-55

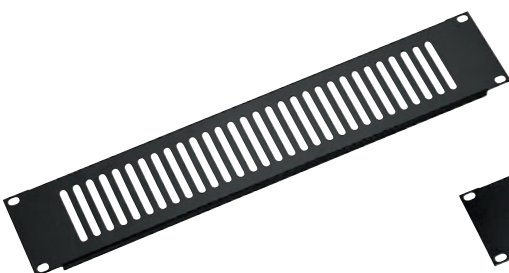



RACKMOUNT STORAGE

491/2	
Special features	with keylock heavy-duty slides
Material	steel
Depth	390 mm

Order No.

black, 2 spaces, 7,17 kg	49122-072-55
black, 3 spaces, 7,78 kg	49123-073-55
black, 4 spaces, 8,94 kg	49124-074-55



19" POWER BOX

28664	
Weight	1.07 kg
Special features	per color unit maximum 3600 W total power input under regular technical connection conditions; CE-mark
Material	aluminum
Height (units)	1 space
Connection	electric cable 2 m
Electrical connection data	400 V AC 3, N, PE CEE 16A, 5-pin 6h
Sockets	6 piece on the front side
Plug	5-pin CEE

Order No.

black	28664-000-55
-------	--------------

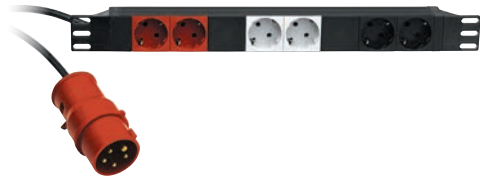

19"-POWER BOX

28665	
Weight	0.76 kg
Special features	maximum 3600 W total power input under regular technical connection conditions; CE-mark
Material	aluminum
Height (units)	1 space
Connection	electric cable 2 m
Electrical connection data	230 V AC 50Hz
On/off switch	Yes
Sockets	7 piece on the back side
Plug	shockproofed

Order No.

black	28665-000-55
-------	--------------



19" POWER BOX

28668	
Weight	0.52 kg
Special features	maximum 3600 W total power input under regular technical connection conditions; CE-mark
Material	aluminum
Height (units)	1 space
Connection	without cable
Electrical connection data	230 V AC 50Hz
On/off switch	Yes
Sockets	6 piece on the back side
Plug	power-con

Order No.

black	28668-000-55
-------	--------------



19" POWER BOX

28670	
Weight	0.76 kg
Special features	maximum 3600 W total power input under regular technical connection conditions; CE-mark
Material	aluminum
Height (units)	1 space
Connection	electric cable 2 m
Electrical connection data	230 V AC 50Hz
On/off switch	No
Sockets	8 piece on the front side
Plug	shockproofed

Order No.

black	28670-000-55
-------	--------------



19" POWER BOX

28675	
Weight	0.74 kg
Special features	maximum 3600 W total power input under regular technical connection conditions; CE-mark
Material	aluminum
Height (units)	1 space
Connection	electric cable 2 m
Electrical connection data	230 V AC 50Hz
On/off switch	Yes
Sockets	7 piece on the front side
Plug	shockproofed

Order No.

black	28675-000-55
-------	--------------



**19" POWER BOX****28676**

Weight	1.3 kg
Special features	maximum 3600 W total power input under regular technical connection conditions; CE-mark
Material	aluminum
Height (units)	1 space
Connection	electric cable 2 m
Electrical connection data	230 V AC 50Hz
On/off switch	Yes
Sockets	6 piece on the front and back side
Plug	shockproofed

Order No.

black 28676-000-55

**SINGLE RACK RAIL****28410**

Weight	0.24 kg
Special features	other space units upon request
Material	steel
Height (units)	10 spaces

Order No.

black 28410-000-55

**SUPPORT BRACKET****286/8**

Special features	other measurements on request
Material	steel
Suitable for	19"-equipment

Order No.

4 holes,
370 mm long, 0,54 kg 28680-000-55

8 holes,
370 mm long, 0,57 kg 28681-000-55

10 holes,
493 mm long, 0,73 kg 28687-000-55

**DOUBLE RACK RAIL****28635**

Weight	2.28 kg
Special features	other space units on request
Material	steel
Height (units)	35 spaces

Order No.

black 28635-000-55

**CABLE HANGER****49010**

Weight	0.54 kg
Special features	for 14 cables side trays hold loose items
Material	steel

Order No.

black 49010-000-55

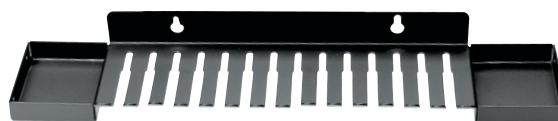
**HEADPHONE HOLDER****49302**

Weight	0.114 kg
Special features	swiveling
Material	steel
Height (units)	2 spaces

Order No.

black 49302-012-55



PLEXIGLASS SECURITY COVER

493/3

Special features	with hinge and key lock
Material	frame steel, window-pane plexiglass

Order No.

black, 2 spaces, 0,86 kg 49332-000-00

black, 4 spaces, 1,16 kg 49334-000-00



K&M KÖNIG & MEYER
Stands For Music





MICROPHONE STANDS

We're especially proud of these: König & Meyer microphone stands have boasted an outstanding reputation worldwide for decades. There is hardly a music studio, concert or event that isn't outfitted with König & Meyer microphone stands.

What convinces the musicians?

The solid, tough clamp elements and mechanics, or the choice of materials and the quality of the finish? We think it's the sum of all the parts of a stand that is made with precision and a love for detail.

All microphone stands are also available in 5/8" thread



MICROPHONE STAND

199	BASELINE
Weight	1.52 kg
Special features	plastic base; folds very small
Material	steel
Leg construction	socket with foldable legs
Threaded connector	3/8"
Height adjustment	non-scratching locking screws
Rod combination	3-piece folding design
Size when folded	560 mm
Height	from 625 to 1,480 mm

Order No.

black 19900-300-55

MICROPHONE STAND

260	BASELINE
Weight	5.74 kg
Special features	anti-vibration rubber insert for noise filtration
Material	steel
Base diameter	250 mm
Leg construction	heavy round cast-iron base
Threaded connector	3/8"
Height adjustment	clutch
Rod combination	2-piece folding design
Height	from 870 to 1,565 mm

Order No.

nickel 26000-300-01
black 26000-300-55

Accessories

Knurled washer 26004 203
Carrying case 26019 199

MICROPHONE STAND

260/1	BASELINE
Weight	3.6 kg
Special features	anti-vibration rubber insert for noise filtration
Material	steel
Base diameter	250 mm
Leg construction	flat round cast-iron base
Threaded connector	3/8"
Height adjustment	clutch
Rod combination	2-piece folding design
Height	from 870 to 1,575 mm

Order No.

nickel 26010-300-01
black 26010-300-55

Accessories

Knurled washer 26004 203
Carrying case 26019 199



MICROPHONE STAND

NEW

260/1	BASELINE
Weight	3 kg
Special features	significantly light-weight, but nonetheless stable due to the ingenious round base with an integrated steel plate with an attractive plastic cover; circumferential rubber profile reduces undesirable vibration and footfall noise
Material	steel
Base diameter	275 mm
Leg construction	round base
Threaded connector	3/8"
Height adjustment	clutch
Rod combination	2-piece folding design
Height	from 870 to 1,575 mm

Order No.

pure white 26010-300-76

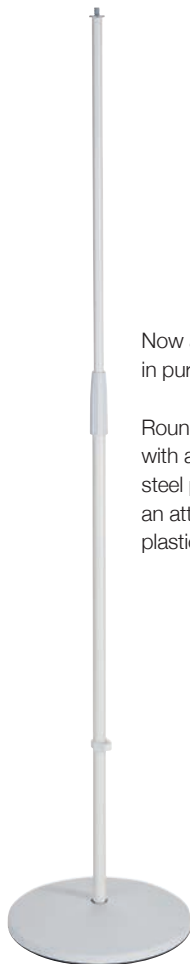

Now available in pure white.

Round base with an integrated steel plate with an attractive plastic cover.

MICROPHONE STAND

201/2	TOPLINE
Weight	2 kg
Special features	zinc die-cast base; short-legged design
Material	steel
Leg construction	socket with foldable legs
Threaded connector	3/8"
Height adjustment	clutch
Rod combination	2-piece folding design
Height	from 890 to 1,590 mm

Order No.

black 20120-300-55



Short-legged design

MICROPHONE STAND

201A/2	TOPLINE
Weight	2.4 kg
Special features	zinc die-cast base
Material	steel
Leg construction	socket with foldable legs
Threaded connector	3/8"
Height adjustment	clutch
Rod combination	2-piece folding design
Height	from 900 to 1,605 mm

Order No.

nickel 20130-300-01
black 20130-300-55



ONE HAND MICROPHONE STAND

25680	TOPLINE
Weight	2.14 kg
Special features	zinc die-cast base
Material	leg construction made from steel, rod combination made from aluminum
Leg construction	socket with foldable legs
Threaded connector	3/8"
Height adjustment	»Soft-Touch« one-hand clutch
Rod combination	2-piece folding design
Height	from 1,100 to 1,820 mm

Order No.
black 25680-300-55

STACKABLE MICROPHONE STAND

26045	TOPLINE
Weight	3.4 kg
Special features	round cast-iron base with a cut-out design that allows for stacking of up to 5 microphone stands
Material	steel
Base diameter	278 mm
Leg construction	flat round cast-iron base
Threaded connector	3/8"
Height adjustment	clutch
Rod combination	2-piece folding design
Height	from 870 to 1,575 mm

Order No.
black 26045-300-55

Accessories	Page
Knurled washer 26004	203
Carrying case 26019	199

STACKABLE ONE-HAND MICROPHONE STAND

26075	TOPLINE
Weight	3 kg
Special features	round cast-iron base with a cut-out design that allows for stacking of up to 5 microphone stands
Material	die-cast base, rod combination made from aluminum
Base diameter	278 mm
Leg construction	flat round cast-iron base
Threaded connector	3/8"
Height adjustment	»Soft-Touch« one-hand clutch
Rod combination	2-piece folding design
Height	from 1,060 to 1,790 mm

Order No.
black 26075-300-55

Accessories	Page
Knurled washer 26004	203
Carrying case 26019	199



»Soft-Touch« one-hand clutch mechanism which easily raises and lowers the mic



Round cast-iron base with a cut-out design that allows for stacking of up to 5 microphone stands

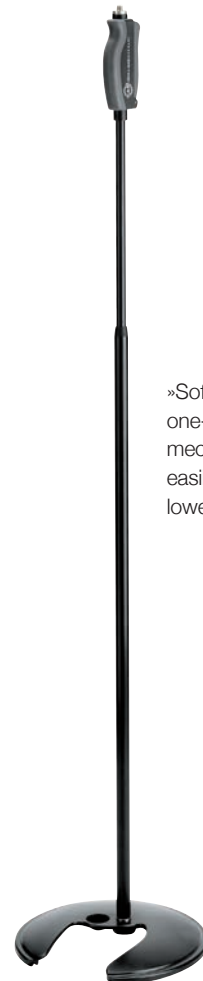

»Soft-Touch« one-hand clutch mechanism which easily raises and lowers the mic

ONE HAND MICROPHONE STAND

26085	TOPLINE
Weight	3.2 kg
Special features	anti-vibration rubber insert for noise filtration
Material	die-cast base, rod combination made from aluminum
Base diameter	250 mm
Leg construction	flat round cast-iron base
Threaded connector	3/8"
Height adjustment	»Soft-Touch« one-hand clutch
Rod combination	2-piece folding design
Height	from 1,060 to 1,790 mm

Order No.	
black	26085-300-55

Accessories	Page
Knurled washer 26004	203
Carrying case 26019	199



»Soft-Touch« one-hand clutch mechanism which easily raises and lowers the mic

MICROPHONE STAND

200	STARLINE
Weight	2.7 kg
Special features	zinc die-cast base; with built-in anti-vibration filters in legs; suitable for studios; heavy metal legs
Material	steel
Leg construction	socket with foldable legs
Threaded connector	3/8"
Height adjustment	clutch
Rod combination	2-piece folding design
Height	from 910 to 1,615 mm

Order No.	
black	20000-300-55



Anti-vibration filters to isolate microphones

MICROPHONE STAND »SOFT-TOUCH«

26010	STARLINE
Weight	3.8 kg
Special features	anti-vibration rubber insert for noise filtration; gray powder coating; low light reflection
Material	steel
Base diameter	250 mm
Leg construction	flat round cast-iron base
Threaded connector	3/8"
Height adjustment	clutch
Rod combination	2-piece folding design
Height	from 870 to 1,575 mm

Order No.	
gray	26010-300-87

Accessories	Page
Carrying case 26019	199



Easy-to-grip clutch with elastic surface

Attractive gray powder coating; Low light reflection; Eye-catcher on every stage

MICROPHONE STAND

26125	STARLINE
Weight	3.36 kg
Special features	stable, lightweight metal round base with plastic cover; full circle anti-vibration rubber damping ring for noise filtration; large support area provides great stability
Material	steel
Base diameter	275 mm
Leg construction	round base
Threaded connector	3/8"
Height adjustment	clutch
Rod combination	2-piece folding design
Height	from 1,000 to 1,700 mm

Order No.

black 26125-300-55

MICROPHONE STAND

26150	STARLINE
Weight	2.5 kg
Special features	»Chrome-line«; chrome-plated clutch; anti-vibration rubber bumps for noise filtration
Material	glass base, rod combination made from steel
Base diameter	250 mm
Leg construction	round glass base
Threaded connector	3/8"
Height adjustment	clutch
Rod combination	2-piece folding design
Height	from 870 to 1,570 mm

Order No.

chrome 26150-300-02

Accessories

Carrying case 26019

Page

199

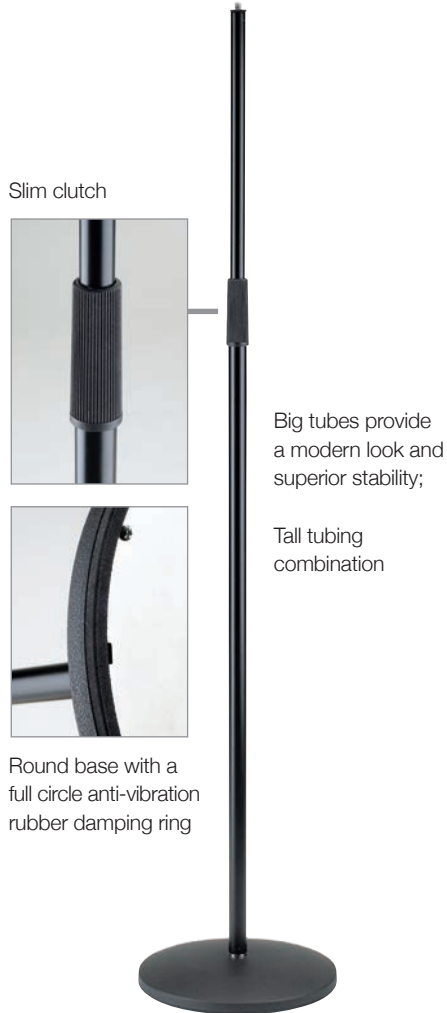

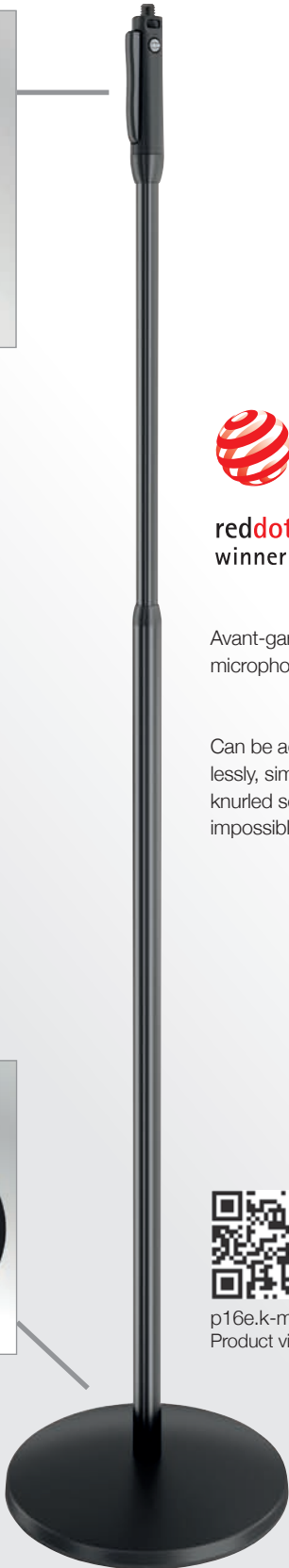

**reddot design award
winner 2013**

Avant-garde, one-hand
microphone stand;

Can be adjusted sound-
lessly, simply and easily;
knurled screw is
impossible to lose



p16e.k-m.de
Product video

**ONE-HAND
MICROPHONE STAND »ELEGANCE«**

26200	STARLINE
Weight	3 kg
Special features	triangular-shaped rods; knurled screw is impossible to lose; can be adjusted soundlessly, simply and easily; significantly light-weight, but nonetheless stable due to the ingenious round base with an integrated steel plate with an attractive plastic cover; circumferential rubber profile reduces undesirable vibration and footfall noise
Material	rod combination made from aluminum, handle bar zinc die-cast
Base diameter	275 mm
Leg construction	round base
Threaded connector	3/8"
Height adjustment	one-hand clutch
Rod combination	2-piece folding design
Height	from 1,055 to 1,735 mm

Order No.

black 26200-300-55

The elegant combination of triangular-shaped sections and the new design of the slender one-hand adjustment mechanism go harmoniously with standard microphone clips and microphones. The height of the stand can be adjusted soundlessly, simply and easily using the unique one-hand clutch. The stand is significantly lightweight, but nonetheless stable due to the ingenious round base with an integrated steel plate with an attractive plastic cover. The base's circumferential rubber profile reduces undesirable vibration and footfall noise even when the stand is tilted far over to the side.



Smoothly and silently adjustable one-hand system

Lightweight, but nonetheless stable steel base



ONE-HAND MICROPHONE STAND »PERFORMANCE«

26250	STARLINE
Weight	2.99 kg
Special features	round-shaped rods; soundless and easy height adjustment; significantly lightweight, but nonetheless stable due to the ingenious round base with an integrated steel plate with an attractive plastic cover; circumferential rubber profile reduces undesirable vibration and footfall noise
Material	rod combination made from aluminum, handle bar plastic
Base diameter	275 mm
Leg construction	round base
Threaded connector	3/8"
Height adjustment	one-hand clutch
Rod combination	2-piece folding design
Height	from 1,055 to 1,750 mm

Order No.

black 26250-300-55

The stable combination of high quality round-shaped rods and the elegant one-hand adjustment present a harmonious overall appearance. With the practical one-hand system the height of the stand can be adjusted smoothly and silently (no scratching noises). The ingenious steel base with its elegant plastic cover provides more stability even though the base is much lighter. A circular rubber insert ring on the base also reduces unwanted vibrations and foot traffic noise, even when the stand is placed in extreme positions. In addition, the floor (e.g. wood floor) is protected from possible damage.

MICROPHONE STAND

25400	BASELINE
Weight	1.84 kg
Special features	boom arm non-detachable
Material	steel
Base diameter	660 mm
Leg construction	U-profile legs snap into socket
Threaded connector	3/8"
Height adjustment	clutch
Rod combination	2-piece folding design
Boom arm	one-piece design
Boom arm clamping	locking knob
Boom arm length	680 mm
Size when folded	870 x 80 x 95 mm
Height	from 890 to 1,600 mm

Order No.	
black	25400-300-55

MICROPHONE STAND

21070	BASELINE
Weight	2.19 kg
Special features	zinc die-cast base
Material	steel
Leg construction	socket with foldable legs
Threaded connector	3/8"
Height adjustment	clutch
Rod combination	2-piece folding design
Boom arm	one-piece design
Boom arm clamping	wing nut
Boom arm length	805 mm
Height	from 900 to 1,600 mm

Order No.	
black	21070-300-55

Accessories	Page
Carrying case 21421	198

MICROPHONE STAND

27105	BASELINE
Weight	2.3 kg
Special features	plastic base
Material	steel
Leg construction	socket with foldable legs
Threaded connector	3/8"
Height adjustment	clutch
Rod combination	2-piece folding design
Boom arm	one-piece design
Boom arm clamping	wing nut
Boom arm length	805 mm
Height	from 900 to 1,600 mm

Order No.	
black	27105-300-55

Accessories	Page
Carrying case 21421	198



MICROPHONE STAND

27195 **BASELINE**

Weight	2.3 kg
Special features	plastic base
Material	steel
Leg construction	socket with foldable legs
Threaded connector	3/8"
Height adjustment	clutch
Rod combination	2-piece folding design
Boom arm	2-piece telescopic design
Boom arm clamping	wing nut
Boom arm length	from 425 to 725 mm
Height	from 900 to 1,600 mm

Order No.

black 27195-300-55

Accessories

Page

Carrying case 21421 198





An absolute classic -
often imitated -
never duplicated!

Designed for heavy use.

MICROPHONE STAND

210/2	TOPLINE
Weight	3.2 kg
Special features	the industry standard; stable and sturdy; zinc die-cast base; designed for heavy use
Material	steel
Leg construction	socket with foldable legs
Threaded connector	3/8"
Height adjustment	clutch
Rod combination	2-piece folding design
Boom arm	one-piece design
Boom arm clamping	T-bar locking screw
Boom arm length	840 mm
Height	from 900 to 1,605 mm

Order No.

nickel	21020-300-01
black	21020-300-55

Often copied – but never duplicated – a König & Meyer classic. High-quality materials and quality craftsmanship have made this stand a global standard for microphone stands for over 50 years.

Accessories	Page
Carrying case 21421	198



MICROPHONE STAND

210/9	TOPLINE
Weight	3.2 kg
Special features	stable and sturdy; zinc die-cast base
Material	steel
Leg construction	socket with foldable legs
Threaded connector	3/8"
Height adjustment	clutch
Rod combination	2-piece folding design
Boom arm	2-piece telescopic design
Boom arm clamping	T-bar locking screw
Boom arm length	from 460 to 770 mm
Height	from 900 to 1,605 mm

Order No.

nickel	21090-300-01
black	21090-300-55

Accessories

	Page
Carrying case 21421	198

MICROPHONE STAND

210/6	TOPLINE
Weight	3 kg
Special features	zinc die-cast base
Material	steel
Leg construction	socket with foldable legs
Threaded connector	3/8"
Height adjustment	clutch
Rod combination	2-piece folding design
Boom arm	one-piece design
Boom arm clamping	wing nut
Boom arm length	805 mm
Height	from 925 to 1,630 mm

Order No.

nickel	21060-300-01
black	21060-300-55

Accessories

	Page
Carrying case 21421	198

MICROPHONE STAND

210/8	TOPLINE
Weight	3 kg
Special features	zinc die-cast base
Material	steel
Leg construction	socket with foldable legs
Threaded connector	3/8"
Height adjustment	clutch
Rod combination	2-piece folding design
Boom arm	2-piece telescopic design
Boom arm clamping	wing nut
Boom arm length	from 425 to 725 mm
Height	from 925 to 1,630 mm

Order No.

nickel	21080-300-01
black	21080-300-55

Accessories

	Page
Carrying case 21421	198



MICROPHONE STAND

252	TOPLINE
Weight	2.9 kg
Special features	zinc die-cast base folds very small
Material	steel
Leg construction	socket with foldable legs
Threaded connector	3/8"
Height adjustment	non-scratching locking screws
Rod combination	3-piece folding design
Boom arm	2-piece telescopic design
Boom arm clamping	T-bar locking screw
Boom arm length	from 490 to 795 mm
Height	from 620 to 1,470 mm

Order No.	
black	25200-300-55

Accessories	Page
Carrying case 10811	44



MICROPHONE STAND

26145	TOPLINE
Weight	6.2 kg
Special features	slim clutch; tall tubing combination; big tubes provide a modern look and a superior stability
Material	steel
Base diameter	300 mm
Leg construction	heavy round cast-iron base
Threaded connector	3/8"
Height adjustment	clutch
Rod combination	2-piece folding design
Boom arm	2-piece telescopic design
Boom arm clamping	T-bar locking screw
Boom arm length	from 470 to 770 mm
Height	from 1,000 to 1,700 mm

Order No.	
black	26145-300-55



Slim clutch;
Tall tubing
combination;
Big tubes provide
a modern look and
a superior stability

MICROPHONE STAND »SOFT-TOUCH«

21060	STARLINE
Weight	3 kg
Special features	zinc die-cast base; gray powder coating; low light reflection
Material	steel
Leg construction	socket with foldable legs
Threaded connector	3/8"
Height adjustment	clutch
Rod combination	2-piece folding design
Boom arm	one-piece design
Boom arm clamping	wing nut
Boom arm length	805 mm
Height	from 925 to 1,630 mm

Order No.	
gray	21060-300-87

Accessories	Page
Carrying case 21421	198

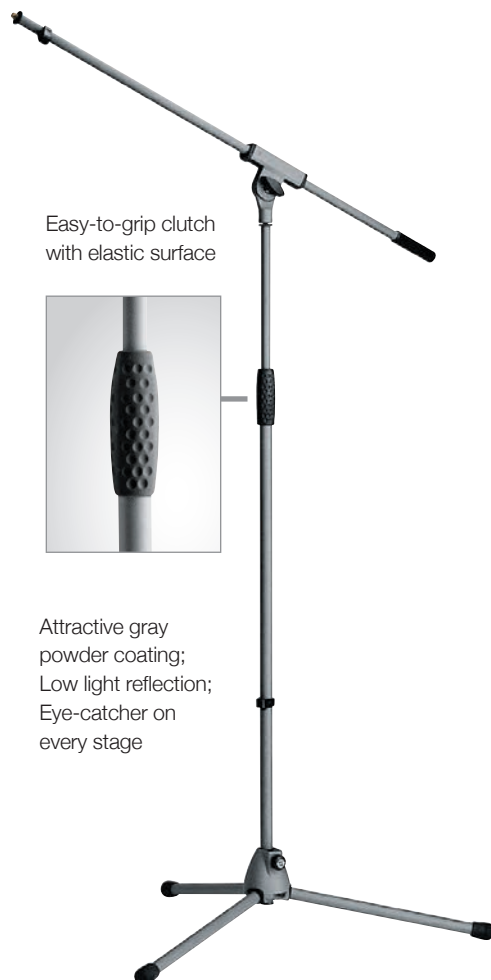

Easy-to-grip clutch
with elastic surface



Attractive gray
powder coating;
Low light reflection;
Eye-catcher on
every stage



Easy-to-grip clutch with elastic surface



Attractive gray Soft-Touch powder coating; Low light reflection; Eye-catcher on every stage

MICROPHONE STAND »SOFT-TOUCH«

21080	STARLINE
Weight	3 kg
Special features	zink die-cast base; gray powder coating; low light reflection
Material	steel
Leg construction	socket with foldable legs
Threaded connector	3/8"
Height adjustment	clutch
Rod combination	2-piece folding design
Boom arm	2-piece telescopic design
Boom arm clamping	wing nut
Boom arm length	from 425 to 725 mm
Height	from 925 to 1,630 mm

Order No.

gray 21080-300-87

The attractive basalt gray powder coating gives the microphone stand an extravagant accent and reduces light reflection to a minimum.

This stand is perfect for professional use on the public stage. Further features include the easy-to-grip »Soft-Touch« clutch with an elastic plastic cover and a boom arm with user-friendly wing nut adjustment.

Accessories

Carrying case 21421

Page

198





The exclusive microphone stand

MICROPHONE STAND

25600	STARLINE
Weight	3.4 kg
Special features	zinc die-cast base; no parts to lose; clamping lever can be used for cable management
Material	steel
Leg construction	socket with foldable legs
Threaded connector	3/8"
Height adjustment	clutch
Rod combination	2-piece folding design
Boom arm	2-piece telescopic design
Boom arm clamping	heavy-duty all metal clamping lever
Boom arm length	from 600 to 955 mm
Height	from 970 to 1,640 mm

Order No.

black 25600-300-55

The unique design retains all adjustment elements. The distinctive ergonomically designed and patented clamping lever easily and comfortably adjusts the boom arm in any position and can also hold microphone cables. This high-quality stand is impressively robust.

Accessories

Carrying case 21421

Page

198



OVERHEAD MICROPHONE STAND

21021	
Weight	5.9 kg
Special features	zinc die-cast base; extra high; longer legs
Material	steel
Leg construction	socket with foldable legs
Threaded connector	3/8"
Height adjustment	clutch
Rod combination	2-piece folding design
Boom arm	one-piece design
Boom arm clamping	T-bar locking screw
Boom arm length	1,065 mm
Height	from 1,120 to 2,010 mm

Order No.	
black	21021-300-55

OVERHEAD MICROPHONE STAND

20800	
Weight	3.8 kg
Special features	for special stage and studio applications; adjustable up to 3.10 m
Material	steel
Base diameter	1,000 mm
Leg construction	tube legs with cross braces
Threaded connector	3/8"
Height adjustment	clamping element with locking screw
Rod combination	3-piece folding design
Height	from 1,350 to 3,100 mm

Order No.	
black	20800-309-55

Accessories	Page
Carrying case 21422	231

OVERHEAD MICROPHONE STAND

20811	
Weight	10.5 kg
Special features	adjustable up to 4.40 m; additional safety rings included
Material	steel
Base diameter	1,485 mm
Leg construction	tube legs with double cross braces
Threaded connector	1/2"
Height adjustment	non-scratching locking screws
Rod combination	3-piece folding design
Height	from 1,850 to 4,400 mm

Order No.	
black	20811-409-55

Accessories	Page
Boom arm 21231	181

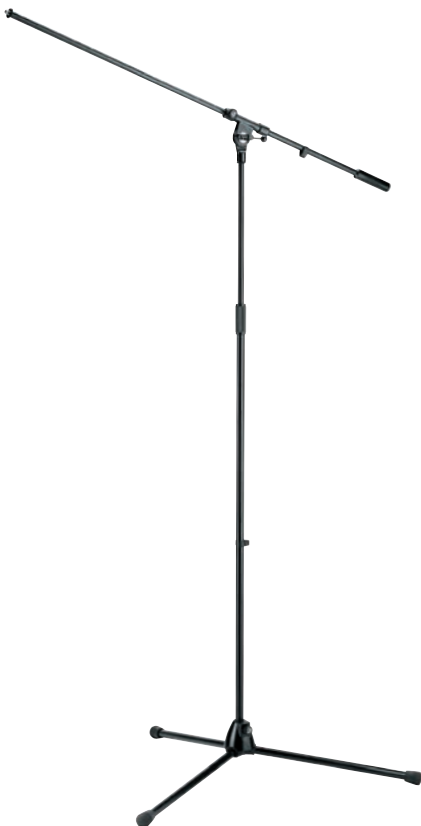

OVERHEAD MICROPHONE STAND

21411	
Weight	4.94 kg
Special features	for special stage and studio applications; rod combination with additional locking mechanism
Material	steel
Leg construction	tube legs with double cross braces
Threaded connector	1/2"
Height adjustment	clamping element with locking screw
Max. load capacity	12 kg
Rod combination	2-piece folding design
Height	from 1,480 to 2,290 mm

Order No.
black 21411-400-55

Accessories	Page
Boom arm 21231	181
Carrying case 21311	230
Carrying case »Pro« 21312	231



OVERHEAD MICROPHONE STAND

21430	
Weight	17.42 kg
Special features	heavy die-cast base with low centre of gravity for high level safety; 3 lockable castor wheels; extendable boom arm with a 3 kg counterweight; additional mini boom arm with 5/8"- and 3/8" thread and length of 245 mm
Material	steel
Base diameter	660 mm
Leg construction	cast-iron base
Threaded connector	5/8"
Height adjustment	clamping element with locking screw
Rod combination	2-piece folding design
Boom arm clamping	T-bar locking screw
Boom arm length	from 1,100 to 2,000 mm
Height	from 1,340 to 2,200 mm

Order No.
black 21430-500-55



MICROPHONE STAND

255	
Weight	4.1 kg
Special features	zinc die-cast base; extra low design
Material	steel
Leg construction	socket with foldable legs
Threaded connector	3/8"
Boom arm	2-piece telescopic design
Boom arm clamping	T-bar locking screw
Boom arm length	from 870 to 1,550 mm
Height	290 mm

Order No.

black	25500-300-55
-------	--------------

MICROPHONE STAND

259	
Weight	2.2 kg
Special features	low-level microphone stand; zinc die-cast base
Material	steel
Leg construction	socket with foldable legs
Threaded connector	3/8"
Height adjustment	clutch
Rod combination	2-piece folding design
Boom arm	2-piece telescopic design
Boom arm clamping	T-bar locking screw
Boom arm length	from 470 to 775 mm
Height	from 425 to 645 mm

Order No.

black	25900-300-55
-------	--------------

Accessories

Accessories	Page
Carrying case 10811	44

MICROPHONE STAND

259/1	
Weight	1.9 kg
Special features	extra low design; zinc die-cast base
Material	steel
Leg construction	socket with foldable legs
Threaded connector	3/8"
Boom arm	one-piece design
Boom arm clamping	T-bar locking screw
Boom arm length	525 mm
Height	280 mm

Order No.

black	25910-300-55
-------	--------------

Accessories

Accessories	Page
Carrying case 10811	44



MICROPHONE STAND »RIEN«**25950**

Weight	2.98 kg
Special features	extra low design; zinc die-cast base; very short, heavy legs
Material	steel
Leg construction	socket with foldable legs
Threaded connector	3/8"
Boom arm	2-piece telescopic design
Boom arm clamping	wing nut
Boom arm length	from 425 to 725 mm
Height	280 mm

Order No.

black	25950-300-55
-------	--------------

The low-level stand is particularly suitable for bass drums or bass amplifiers. Very short and heavy legs mean this stand needs very little standing space. A telescopic boom arm completes the features of this compact unit.

**Accessories****Page**

Carrying case 14303

72



MICROPHONE STAND

25960	
Weight	5.25 kg
Special features	anti-vibration rubber insert for noise filtration
Material	steel
Base diameter	250 mm
Leg construction	heavy round cast-iron base
Threaded connector	3/8"
Boom arm	2-piece telescopic design
Boom arm clamping	wing nut
Boom arm length	from 425 to 725 mm
Height	430 mm

Order No.

black 25960-300-55

MICROPHONE STAND

23320	
Weight	2.4 kg
Special features	anti-vibration rubber insert for noise filtration
Material	steel
Base diameter	250 mm
Leg construction	flat round cast-iron base
Threaded connector	3/8"
Height adjustment	clutch
Rod combination	2-piece folding design
Height	from 217 to 347 mm

Order No.

black 23320-300-55

MICROPHONE STAND

23323	
Weight	2.55 kg
Special features	anti-vibration rubber insert for noise filtration
Material	steel
Base diameter	250 mm
Leg construction	flat round cast-iron base
Threaded connector	3/8"
Height adjustment	clutch
Rod combination	2-piece folding design
Height	from 350 to 570 mm

Order No.

black 23323-300-55



MICROPHONE STAND »SOFT-TOUCH«

25900	
Weight	2.1 kg
Special features	low-level microphone stand; zinc die-cast base; gray powder coating; low light reflection
Material	steel
Leg construction	socket with foldable legs
Threaded connector	3/8"
Height adjustment	clutch
Rod combination	2-piece folding design
Boom arm	2-piece telescopic design
Boom arm clamping	T-bar locking screw
Boom arm length	from 470 to 775 mm
Height	from 425 to 645 mm

Order No.

gray 25900-370-87

MICROPHONE STAND »SOFT-TOUCH«

25910	
Weight	1.9 kg
Special features	extra low design; die-cast base; gray powder coating; low light reflection
Material	steel
Leg construction	socket with foldable legs
Threaded connector	3/8"
Boom arm	one-piece design
Boom arm clamping	T-bar locking screw
Boom arm length	525 mm
Height	280 mm

Order No.

gray 25910-300-87

Accessories

Carrying case 10811

Page

44

Easy-to-grip clutch with elastic surface



Attractive gray powder coating; Low light reflection; Eye-catcher on every stage



BOOM ARM

211	
Weight	0.7 kg
Material	steel
Threaded connector	3/8"
Boom arm	one-piece design
Boom arm length	800 mm
Clamping	T-bar locking screw

Order No.

nickel	21100-300-01
black	21100-300-55

BOOM ARM

211/1	
Weight	0.64 kg
Material	steel
Threaded connector	3/8"
Boom arm	2-piece telescopic design
Boom arm length	from 470 to 770 mm
Clamping	T-bar locking screw

Order No.

nickel	21110-300-01
black	21110-300-55

BOOM ARM

21140	
Weight	0.58 kg
Material	steel
Threaded connector	3/8"
Boom arm	2-piece telescopic design
Boom arm length	from 425 to 725 mm
Clamping	wing nut

Order No.

black	21140-300-55
-------	--------------



BOOM ARM

21160	
Weight	0.5 kg
Special features	short boom arm
Material	steel
Threaded connector	3/8"
Boom arm	one-piece design
Boom arm length	395 mm
Clamping	wing nut

Order No.
black 21160-300-55

BOOM ARM

21231	
Weight	5.3 kg
Special features	connecting thread 1/2"; adjustable heavy counterweight included
Material	steel
Threaded connector	3/8"
Boom arm	2-piece telescopic design
Boom arm length	from 1,100 to 2,000 mm
Clamping	T-bar locking screw
Fits	20811, 21411

Order No.
black 21231-400-55

Accessories	Page
Carrying case 21422	231
Thread adapter 21900	200

MINI BOOM ARM

21431	
Weight	0.31 kg
Special features	suitable for overhead uses
Material	steel
Threaded connector	3/8" and 5/8"
Boom arm	one-piece design
Boom arm length	290 mm
Clamping	wing nut

Order No.
black 21431-300-55



TABLE MICROPHONE STAND

23105	
Weight	0.07 kg
Special features	can be used as microphone handle
Material	plastic
Leg construction	foldable legs
Threaded connector	1/4" or 3/8"
Height	70 mm

Order No.
black 23105-300-55

TABLE MICROPHONE STAND

231/1	
Weight	0.08 kg
Material	plastic base, steel legs
Leg construction	foldable legs
Threaded connector	3/8"
Height	60 mm

Order No.
nickel 23110-300-01

TABLE MICROPHONE STAND

232	
Weight	1.35 kg
Special features	anti-vibration rubber insert for noise filtration; screw in threaded bolt
Material	steel
Base diameter	130 mm
Leg construction	heavy round cast-iron base
Threaded connector	3/8"
Height	175 mm

Order No.
black 23200-300-55



TABLE MICROPHONE STAND

23220	
Weight	1.05 kg
Special features	anti-vibration rubber insert for noise filtration
Material	steel
Base diameter	130 mm
Leg construction	heavy round cast-iron base
Threaded connector	3/8"
Height	45 mm

Order No.

black 23220-300-55

TABLE MICROPHONE STAND

23230	
Weight	0.75 kg
Special features	attractive trilobular base; anti-vibration circular rubber insert ring
Material	steel
Base diameter	137 mm
Leg construction	steel trilobular base
Threaded connector	3/8"
Height	152 mm

Order No.

black 23230-300-55

DESIGN MICROPHONE TABLE STAND

23250	
Weight	0.7 kg
Special features	stable and sturdy; special design; surface area for company logo etc.; space saving flat foot construction
Material	steel
Threaded connector	3/8"
Base dimensions	125 x 130 mm
Height	142 mm

Order No.

black 23250-300-55



Base with new attractive triangle form

Perfect for labelling or your logo



Space saving construction





TABLE MICROPHONE STAND

23266	
Weight	0.33 kg
Special features	compact base; anti-vibration felt insert for noise filtration
Material	steel
Base diameter	64 mm
Leg construction	very small round base
Threaded connector	3/8"
Height	60 mm

Order No.

gray 23266-300-74

TABLETOP MICROPHONE STAND

23150	
Weight	0.41 kg
Special features	easy-to-use clamping levers
Material	steel
Base diameter	250 mm
Leg construction	square tube legs snap into socket
Threaded connector	1/4" or 3/8"
Height adjustment	infinitely variable by means of ergonomically shaped clamping elements
Rod combination	2-piece folding design
Size when folded	230 mm
Height	from 230 to 430 mm

Order No.

black 1/4" 23150-100-55
black 3/8" 23150-300-55

TABLE- /FLOOR MICROPHONE STAND

23325	
Weight	2.51 kg
Special features	anti-vibration rubber insert for noise filtration
Material	steel
Base diameter	180 mm
Leg construction	heavy round cast-iron base
Threaded connector	3/8"
Height adjustment	clutch
Rod combination	2-piece folding design
Height	from 217 to 347 mm

Order No.

black 23325-300-55



Folds compactly



TABLE- /FLOOR MICROPHONE STAND

233	
Weight	2.6 kg
Special features	anti-vibration rubber insert for noise filtration
Material	steel
Base diameter	180 mm
Leg construction	heavy round cast-iron base
Threaded connector	3/8"
Height adjustment	clutch
Rod combination	2-piece folding design
Height	from 355 to 580 mm

Order No.

black 23300-300-55

Accessories

Knurled washer 26004

Page

203

TABLE- /FLOOR MICROPHONE STAND

234	
Weight	2.1 kg
Special features	anti-vibration felt insert for noise filtration; tilt angle adjustment
Material	steel
Leg construction	rectangular cast-iron base
Threaded connector	3/8"
Height adjustment	non-scratching locking screw
Rod combination	2-piece folding design
Base dimensions	170 x 135 mm
Height	from 400 to 640 mm

Order No.

black 23400-300-55

MICROPHONE TABLE BASE

29375	
Weight	0.48 kg
Special features	crackle-free switching; wired
Material	zinc die-cast
Base diameter	130 mm
Control element	switch
Female connector for microphone	3-pin XLR-jack
Pilot light	voltage and mic on/off
Plug connection mixer	3-pin XLR-plug
Height	35 mm

Order No.

black 29375-000-55



MICROPHONE TABLE BASE

29376	
Weight	0.47 kg
Special features	wired
Material	zinc die-cast
Base diameter	130 mm
Female connector for microphone	3-pin XLR-jack
Plug connection mixer	3-pin XLR-plug
Height	35 mm

Order No.
black 29376-000-55

MICROPHONE TABLE BASE

29377	
Weight	0.48 kg
Special features	crackle-free switching; wired
Material	zinc die-cast
Base diameter	130 mm
Control element	push-button (push-to-talk)
Female connector for microphone	3-pin XLR-jack
Pilot light	voltage and mic on/off
Plug connection mixer	3-pin XLR-plug
Height	35 mm

Order No.
black 29377-000-55

MICROPHONE TABLE BASE

29390	
Weight	2.44 kg
Special features	wired
Material	zinc die-cast
Female connector for microphone	3-pin XLR-jack
Plug connection mixer	3-pin XLR-plug
Dimensions	160 x 150 x 51 mm
Length	160 mm

Order No.
black 29390-000-55



GOOSENECK

223	
Weight	0.32 kg
Material	steel
Diameter	15 mm
Male thread	3/8"
Female thread	3/8"
Length	400 mm

Order No.	
nickel	22300-300-01
black	22300-300-55

GOOSENECK

224	
Weight	0.24 kg
Material	steel
Diameter	15 mm
Male thread	3/8"
Female thread	3/8"
Length	300 mm

Order No.	
nickel	22400-300-01
black	22400-300-55

GOOSENECK

225	
Weight	0.18 kg
Material	steel
Diameter	15 mm
Male thread	3/8"
Female thread	3/8"
Length	200 mm

Order No.	
black	22500-300-55



GOOSENECK

226	
Weight	0.09 kg
Material	steel
Diameter	11 mm
Male thread	3/8"
Female thread	3/8"
Length	200 mm

Order No.	
black	22600-300-55

GOOSENECK

227	
Weight	0.6 kg
Material	steel
Diameter	18.5 mm
Male thread	3/8"
Female thread	3/8"
Length	500 mm

Order No.	
black	22700-300-55

GOOSENECK

228	
Weight	0.64 kg
Material	steel
Diameter	18.5 mm
Male thread	3/8"
Female thread	3/8"
Length	600 mm

Order No.	
black	22800-300-55



GOOSENECK

230/1	
Weight	0.26 kg
Special features	lateral cable entry terminating
Material	steel
Diameter	15 mm
Female thread	3/8"
Plug connection	3-pin XLR jack NC3FX, XLR-TYPE
Length	300 mm

Order No.

black 23010-300-55

GOOSENECK

230/2	
Weight	0.28 kg
Special features	not wired
Material	steel
Diameter	15 mm
Plug connection	3-pin XLR jack NC3FX, XLR-TYPE and 3-pin plug NC3MX, XLR-TYPE
Length	300 mm

Order No.

black 23020-000-55

GOOSENECK

230/3	
Weight	0.35 kg
Special features	lateral cable entry terminating
Material	steel
Diameter	15 mm
Female thread	3/8"
Plug connection	3-pin XLR jack NC3FX, XLR-TYPE
Length	400 mm

Order No.

black 23030-300-55



GOOSENECK

230/4	
Weight	0.36 kg
Special features	not wired
Material	steel
Diameter	15 mm
Plug connection	3-pin XLR jack NC3FX, XLR-TYPE and 3-pin plug NC3MX, XLR-TYPE
Length	400 mm

Order No.

black 23040-000-55



MICROPHONE »FISHING POLE«

23750	
Weight	0.46 kg
Special features	rubberized anti-slip grip section; carrying case included
Material	aluminum
Threaded connector	3/8"
Rod combination	3-piece folding design
Length	from 635 to 1,600 mm
Adjustment	large locking rings

Order No.

black 23750-000-55

MICROPHONE »FISHING POLE«

23760	
Weight	0.8 kg
Special features	rubberized anti-slip grip section; carrying case included
Material	aluminum
Threaded connector	3/8"
Rod combination	4-piece folding design
Length	from 950 to 3,220 mm
Adjustment	large locking rings

Order No.

black 23760-000-55

MICROPHONE »FISHING POLE«

23770	
Weight	0.8 kg
Special features	rubberized anti-slip grip section; microphone cable can be routed through the tubing; carrying case included
Material	glass fibre
Threaded connector	3/8" and 5/8"
Max. load capacity	0.5 kg
Rod combination	5-piece folding design
Length	from 1,200 to 4,600 mm
Adjustment	large locking rings

Order No.

black 23770-000-55



MICROPHONE »FISHING POLE« **NEW**

23780	
Weight	0.58 kg
Special features	cables can be placed inside; carrying case included
Material	carbon
Threaded connector	3/8"
Rod combination	5-piece folding design
Length	from 600 to 1,825 mm
Adjustment	clamp lever(s)

Order No.
black 23780-000-55

MICROPHONE »FISHING POLE« **NEW**

23785	
Weight	0.74 kg
Special features	cables can be placed inside; carrying case included
Material	carbon
Threaded connector	3/8"
Rod combination	5-piece folding design
Length	from 800 to 2,825 mm
Adjustment	clamp lever(s)

Order No.
black 23785-000-55



Highly functional locking force

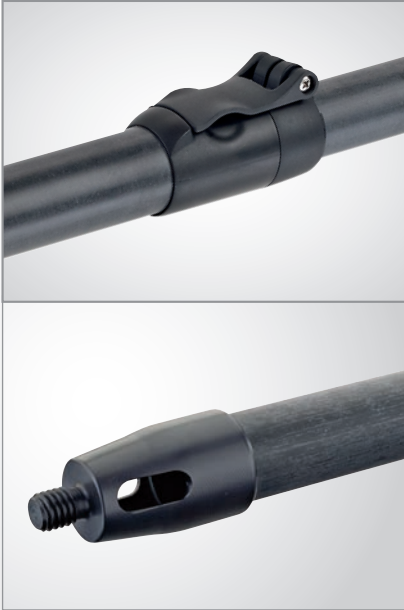

Carbon rod combination



MICROPHONE »FISHING POLE«

NEW

23790

Weight	0.9 kg
Special features	cables can be placed inside; carrying case included
Material	carbon
Threaded connector	3/8"
Rod combination	5-piece folding design
Length	from 1,000 to 3,825 mm
Adjustment	clamp lever(s)

Order No.

black 23790-000-55

Professional carbon microphone fishing pole. The exceptional characteristics of this microphone fishing pole include sturdiness and high stiffness considering its light weight. The four clamps with the innovative locking system are easy to use and provide highly functional locking force. The fishing pole can be adjusted variably between 1,000 and 3,825 mm. Cables can be placed inside the pole. An upholstered carrying case is included.

POPKILLER

23956

Weight	0.22 kg
Special features	double nylon screen with plastic frame
Material	steel
Screw-on to	tube diameter up to 30 mm
Shield diameter	130 mm
Goose neck diameter	8 mm
Goose neck length	330 mm

Order No.

black 23956-000-55

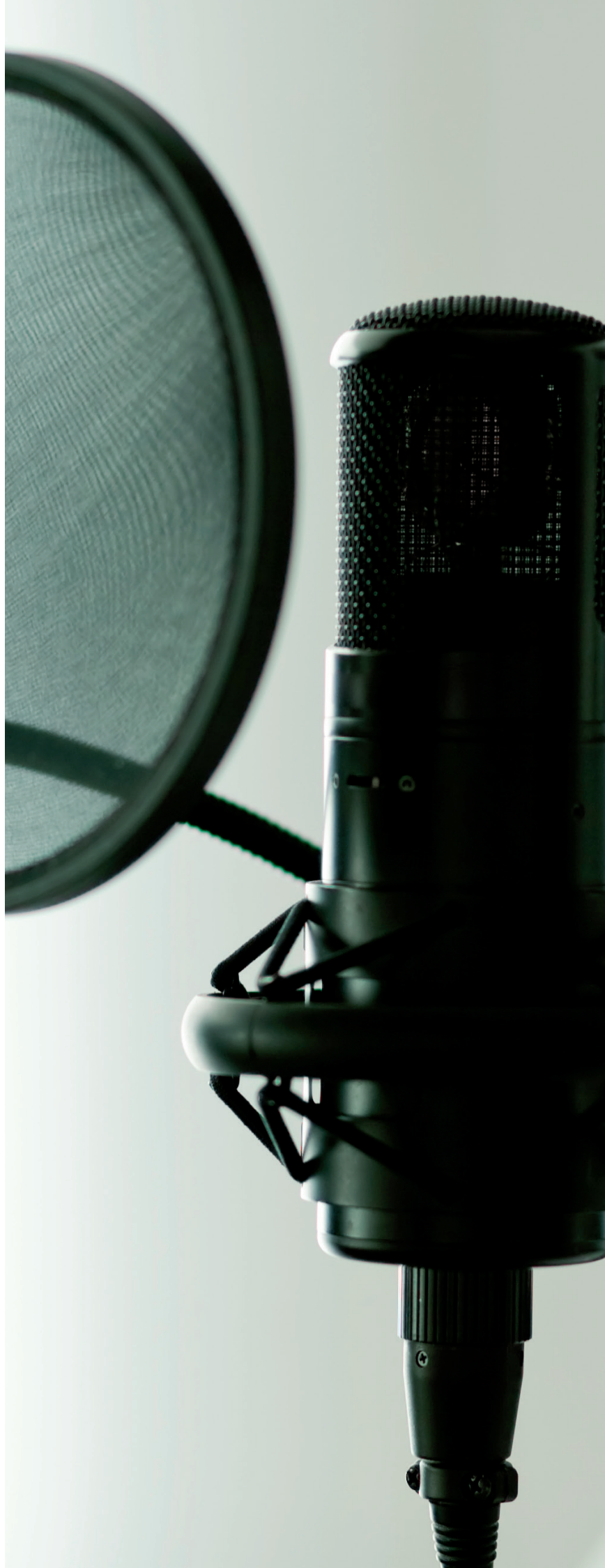

**POPKILLER****23966**

Weight	0.32 kg
Special features	double nylon screen with plastic frame; large shield diameter
Material	steel
Screw-on to	tube diameter up to 30 mm
Shield diameter	200 mm
Goose neck diameter	8 mm
Goose neck length	330 mm

Order No.

black 23966-000-55

This high-quality popkiller is an essential piece of equipment for every professional recording studio. The large nylon screen is a perfect filter for troublesome buzzing and popping sounds. In addition it is better protection than a metal screen against moisture. The stable gooseneck can be mounted on all standard microphone stands and is suitable for many types of performance.



MICROPHONE DESK ARM

23850

Weight	1.72 kg
Material	steel
Threaded connector	3/8" and 5/8"
Max. load capacity	0.8 kg
Length	from 460 to 960 mm
Connection	3-pin XLR-cable 5 m
Clamping range	up to 53 mm

Order No.

black 23850-311-55

Accessories

Table flange 23855

Page

194

MICROPHONE DESK ARM

23860

Weight	1.3 kg
Threaded connector	3/8" and 5/8"
Max. load capacity	1.5 kg
Length	from 460 to 960 mm
Connection	3-pin XLR-cable 6 m
Clamping range	up to 53 mm

Order No.

black 23860-311-55

Accessories

Table flange 23855

Page

194

TABLE FLANGE

23855

Weight	0.23 kg
Base diameter	73 mm
Bore holes	diameter 5.2 mm (3 x)
Height	61 mm
Function	screw-on type
Fits	23850, 23860

Order No.

black 23855-000-55



TABLE CLAMP

237	
Weight	0.18 kg
Material	steel
Threaded connector	3/8"
Clamping range	up to 45 mm

Order No.
black 23700-300-55



MICROPHONE HOLDER FOR DRUMS

24030	
Weight	0.14 kg
Special features	noise and shock absorbing rubber inserts; no parts to lose
Material	steel
Threaded connector	3/8"
Height	60 mm

Order No.
black 24030-300-55



MICROPHONE HOLDER FOR DRUMS

24035	
Weight	0.12 kg
Special features	noise and shock absorbing rubber inserts; no parts to lose; „RIMS“ suitable; microphone can be slid up to 70 mm on the mounting rail
Material	steel
Threaded connector	3/8"
Length	115 mm

Order No.
black 24035-300-55

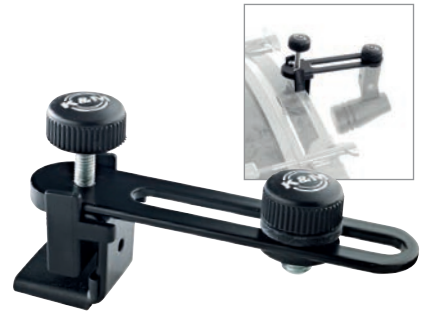

MICROPHONE HOLDER

240/5	
Weight	0.45 kg
Special features	movable retaining clip; adjustable to any angle
Material	steel
Threaded connector	3/8"
Length	308 mm
Clamping range	up to 53 mm

Order No.
black 24050-311-55



TABLE MICROPHONE CLAMP

258	
Weight	0.8 kg
Material	steel
Threaded connector	3/8"
Rod combination	2-piece folding design
Height	from 560 to 1,020 mm
Clamping	locking screw
Clamping range	up to 53 mm
Swivel	360°

Order No.
black 25800-311-55



MICROPHONE ARM

240/1	
Weight	0.94 kg
Material	steel
Threaded connector	3/8"
Boom arm	one-piece design
Boom arm clamping	T-bar locking screw
Boom arm length	605 mm
Height	340 mm
Clamping	locking screws
Clamping range	15 to 30 mm

Order No.
black 24010-314-55



UNIVERSAL CLAMPING HOLDER

19715	
Weight	0.339 kg
Special features	to be attached to tubes up to 30 mm diameter; with 3/8" threaded connector
Material	steel
Max. load capacity	0.75 kg
Length	232 mm
Screw-on to	tube diameter up to 30 mm

Order No.	
black	19715-300-55

Accessories	Page
iPad stand holder 19712	263
iPad mini stand holder 19713	263
iPad Air stand holder 19714	263
Tablet PC stand holder 19742	264

THREADED BOLT

23721	
Weight	0.09 kg
Special features	to upgrade table clamp 23720 for additional applications
Material	steel
Male thread	1/4", 3/8" or 5/8"
Fits	23720

Order No.	
black passivated 1/4" x 31,5 mm	23721-100-25
black passivated 3/8" x 32,5 mm	23721-300-25
black passivated 5/8" x 34,5 mm	23721-500-25

TABLE CLAMP

23720	
Weight	0.23 kg
Special features	includes threaded bolt and universal spanner; maximum 4 threaded bolts for 4 different directions can be applied
Material	steel
Threaded connector	3/8"
Clamping range	up to 53 mm

Order No.	
black 3/8"	23720-300-55

Accessories	Page
Threaded bolt 23721	196



CEILING STAND

22160

Weight	1.3 kg
Material	steel
Threaded connector	3/8"
Height adjustment	clutch
Rod combination	2-piece folding design
Height	from 860 to 1,560 mm

Order No.

black 22160-300-55



MICROPHONE BAR

23510

Weight	0.2 kg
Special features	moveable bars on both sides to position the microphone; no parts to lose; connects to top of mic stands with 3/8" thread
Material	steel
Threaded connector	3/8"
Length	217 mm
Number of knurled screws	2 pieces

Order No.

black 23510-300-55



MICROPHONE BAR

23550

Weight	0.09 kg
Special features	no parts to lose; connects to top of mic stands with 3/8" thread
Material	aluminum
Threaded connector	3/8"
Length	200 mm
Number of knurled screws	2 pieces
Spacing of holes	from 60 to 172 mm

Order No.

black 23550-300-55



MICROPHONE BAR

236

Weight	0.4 kg
Special features	no parts to lose; connects to top of mic stands with 3/8" thread
Material	steel
Threaded connector	3/8"
Length	365 mm
Number of knurled screws	4 pieces

Order No.

black 23600-300-55



MICROPHONE HOLDER

238

Weight	0.18 kg
Special features	no parts to lose
Material	steel
Threaded connector	3/8"
Length	155 mm
Screw-on to	tube diameter up to 30 mm

Order No.

black 23800-300-55



CARRYING CASE

21315

Weight	2.38 kg
Special features	for 6 microphone stands; separate internal compartments prevent scratching and damage of the stands
Material	nylon
Dimensions	1,100 x 180 x 220 mm
Length	1,100 mm
Handle or carrying type	handle and shoulder straps
Fastener	zip fastener

Order No.

21315-000-00



CARRYING CASE

21421

Weight	0.34 kg
Special features	to store two microphone stands; two inside compartments
Material	nylon
Dimensions	1,000 x 130 x 130 mm
Length	1,000 mm
Handle or carrying type	handle
Fastener	zip fastener
Fits	210/2, 210/6, 210/8, 210/9, 21060, 21070, 21080, 21333, 21334, 21336, 21337, 21347, 21356, 21357, 21360, 21364, 21367, 254, 25600, 27105, 27195

Order No.

21421-000-00



CARRYING CASE

26019	
Weight	0.18 kg
Special features	3 internal compartments and fixed Velcro strips provide maximum protection
Material	nylon
Dimensions	1,050 x 250 x 60 mm
Length	1,050 mm
Handle or carrying type	handle and shoulder straps
Fastener	zip fastener
Fits	20170, 260, 260/1, 260/1, 26010, 26045, 26075, 26085, 26150

Order No. _____
26019-000-00



SHEET MUSIC AND DOCUMENT HOLDER

NEW

11510	
Weight	1 kg
Special features	adjustable in angle and depth; high-quality, flexible clamp
Material	steel
Clamping range	up to 53 mm
Music desk dimensions	300 x 200 x 30 mm

Order No. _____
black 11510-000-55



SHEET MUSIC AND DOCUMENT HOLDER

115/2	
Weight	0.93 kg
Special features	adjustable in angle and depth
Material	steel
Screw-on to	tube diameter up to 30 mm
Music desk dimensions	300 x 210 x 30 mm

Order No. _____
black 11520-000-55



SHEET MUSIC AND DOCUMENT HOLDER

11540	
Weight	1.7 kg
Special features	large desk; adjustable in angle and depth
Material	clamping element aluminum with protective plastic inserts, steel desk
Screw-on to	tube diameter up to 30 mm
Music desk dimensions	420 x 300 x 30 mm

Order No. _____
black 11540-000-55



THREAD ADAPTER

215	
Weight	0.01 kg
Male thread	5/8" 27 gauge
Female thread	1/2" and 3/8"

Order No. _____
zinc-plated 21500-000-29



THREAD ADAPTER

216	
Weight	0.022 kg
Special features	with knurled surface
Male thread	3/8"
Female thread	5/8" 27 gauge

Order No. _____
zinc-plated 21600-000-29





THREAD ADAPTER

217

Weight	0.01 kg
Male thread	5/8" 27 gauge
Female thread	3/8"

Order No.

zinc-plated 21700-000-29



THREAD ADAPTER

218

Weight	0.03 kg
Special features	with knurled surface
Male thread	3/8"
Female thread	1/2"

Order No.

zinc-plated 21800-000-29



THREAD ADAPTER

219

Weight	0.036 kg
Special features	with knurled surface
Male thread	1/2"
Female thread	3/8"

Order No.

zinc-plated 21900-000-29



THREAD ADAPTER

21900

Weight	0.03 kg
Special features	goes into the threaded hole of the K&M 21231
Male thread	1/2"
Female thread	3/8"
Fits	21231

Order No.

zinc-plated 21900-208-29



THREAD ADAPTER

21918

Weight	0.03 kg
Special features	with knurled surface
Male thread	M8 x 12 mm
Female thread	3/8"

Order No.

zinc-plated 21918-000-29



THREAD ADAPTER

21920

Weight	0.03 kg
Special features	with knurled surface
Male thread	1/4" x 10 mm
Female thread	3/8"

Order No.

zinc-plated 21920-000-29



THREAD ADAPTER

21980	
Weight	0.04 kg
Special features	with a width across flats of 17
Male thread	M10 x 12 mm
Female thread	3/8"

Order No.
zinc-plated 21980-000-29



THREAD ADAPTER

85040	
Weight	0.01 kg
Material	plastic
Male thread	5/8" 27 gauge
Female thread	3/8"

Order No.
black 85040-000-55



THREAD ADAPTER

85045	
Weight	0.01 kg
Material	plastic
Male thread	5/8" 27 gauge
Female thread	3/8"

Order No.
black 85045-217-55



UNIVERSAL JOINT

19695	
Weight	0.13 kg
Special features	incl. thread adapter 1/4" - 3/8"
Material	steel
Dimensions diameter	29 x 60 mm
Male thread	1/4" or 3/8"
Female thread	3/8" with thread adapter 1/4"

Order No.
black 1/4" male thread 19695-100-55
black 3/8" male thread 19695-300-55

For mobile recorders, cameras, etc.



MICROPHONE CLIP

85035	
Weight	0.03 kg
Special features	elastic mic support
Material	plastic
Threaded connector	3/8" and 5/8"
Microphone clip diameter	diameter 17-22 mm

Order No.
3/8" and 5/8" 85035-000-55
5/8" 85035-500-55



MICROPHONE CLIP

85050	
Weight	0.03 kg
Special features	elastic mic support
Material	plastic
Threaded connector	3/8" and 5/8"
Microphone clip diameter	diameter 22-28 mm

Order No.
3/8" and 5/8" 85050-000-55
5/8" 85050-500-55





MICROPHONE CLIP

85055

Weight	0.04 kg
Special features	elastic mic support
Material	plastic
Threaded connector	3/8" and 5/8"
Microphone clip diameter	diameter 28-34 mm

Order No.

3/8" and 5/8"	85055-000-55
5/8"	85055-500-55



MICROPHONE CLIP

85060

Weight	0.06 kg
Special features	elastic mic support
Material	plastic
Threaded connector	3/8" and 5/8"
Microphone clip diameter	diameter 34-40 mm

Order No.

3/8" and 5/8"	85060-000-55
5/8"	85060-500-55



MICROPHONE CLIP

85070

Weight	0.04 kg
Special features	elastic mic support
Material	plastic
Threaded connector	3/8" and 5/8"
Microphone clip diameter	diameter 34-40 mm

Order No.

3/8" and 5/8"	85070-000-55
5/8"	85070-500-55



TABLE FLANGE

221 a

Weight	0.24 kg
Special features	threaded bolt with cable entry hole
Material	steel
Threaded connector	3/8"
Diameter	73 mm
Bore holes	diameter 5.2 mm (3 x)
Height	150 mm
Function	screw-on type

Order No.

black	22110-300-55
-------	--------------



TABLE FLANGE

221 c

Weight	0.16 kg
Special features	2 threads, for vertical and horizontal connection; threaded bolt with cable entry hole
Material	steel
Threaded connector	3/8"
Diameter	73 mm
Bore holes	diameter 5.2 mm (3 x)
Height	39 mm
Function	screw-on type

Order No.

black	22130-300-55
-------	--------------



TABLE FLANGE

221 d

Weight	0.115 kg
Special features	threaded bolt with cable entry hole
Material	steel
Threaded connector	3/8"
Diameter	73 mm
Bore holes	diameter 5.2 mm (3 x)
Height	13 mm
Function	screw-on type

Order No.

black	22140-300-55
-------	--------------



COUNTER WEIGHT

21105	
Weight	0.8 kg
Special features	used for heavy micro-phones
Material	steel
Diameter	46 mm
Height	60 mm
Suitable for	one-piece K&M boom arms with 3/8" thread or tube diameter 15 mm

Order No.
black 21105-000-55



THREAD ADAPTER

21950	
Weight	0.09 kg
Material	steel
Dimensions diameter	25 x 50 mm
Male thread	M20
Female thread	M20 x 1.25 mm

Order No.
black 21950-000-25



PICK HOLDER

14510	
Weight	0.06 kg
Special features	includes 4 picks of 0.81 mm thickness
Material	plastic
Length	147.5 mm

Order No.
black 14510-000-55

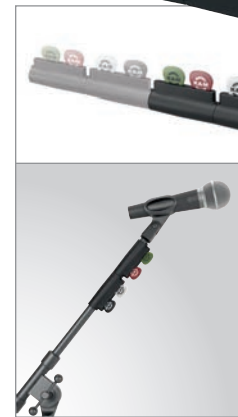

The pick holder has 2 sections. To store even more picks, more units can be linked.

KNURLED WASHER

26004	
Weight	0.012 kg
Special features	to secure rod combination in the round base
Material	aluminum
Diameter	30 mm
Height	5 mm
Suitable for	M20 x 1.25 thread
Fits	233, 260, 260/1, 260/1, 26045, 26075, 26085

Order No.
26004-000-00





Quick Release Adapter makes it easy to quickly switch microphones.

Switching of microphones in just one second - only by pressing the scored plastic handle.



QUICK-RELEASE ADAPTER FOR MICROPHONES

23910	
Weight	0.04 kg
Special features	incl. thread adapter 3/8" - 5/8"
Material	aluminum
Dimensions diameter	22.5 x 50.7 mm
Male thread	3/8" with thread adapter 5/8"
Female thread	5/8" with thread adapter 3/8"

Order No.

black	23910-000-55
-------	--------------

The new König & Meyer Quick Release Adapter makes quickly switching of microphones or other accessories on stage or in studio easier. The adapter consists of two components. The lower section is screwed into the 3/8" or 5/8" microphone stand thread, and the upper section is screwed on using a 3/8" or 5/8" microphone clamp or holder or to other accessories. The lower section ensures the secure and flexible hold of the upper section through 8 punched bore holes. The upper section is used to remove or click the microphone into place using the quick-release adapter. By pressing the scored plastic handle on the upper section both sections can either be disconnected or clicked in place. The adapter is made of high-quality aluminum. A thread adapter is included with the delivery for 5/8" threading. Both adapter components can be left attached to the stand i.e. on the microphone/accessories.







SPEAKER, LIGHTING AND MONITOR STANDS

König & Meyer speaker, lighting and monitor stands set the standard in their class.

Reliability, stability and solidity are particularly important in this area: Nothing less than the safety of the musicians and the audience is at stake.

Intensive research into appropriate materials from among the highest-quality plastics available and the construction of highly durable connecting parts are just some of the individual steps in a long development process.

Our latest models from the "Ring Lock" series also prove that König & Meyer speaker stands aren't just exceptionally reliable, but also provide a big plus when it comes to practicality and handiness.



SPEAKER/MONITOR STAND

21420	BASELINE
Weight	1.32 kg
Special features	lightweight stand
Material	aluminum
Number of legs	3 pieces
Leg construction	tube legs with cross braces
Height adjustment	clamping element with locking screw
Max. load capacity	12 kg
Tube end(s)	diameter 25 mm
Rod combination	2-piece folding design
Height	from 1,265 to 2,105 mm

Order No.
black 21420-000-55

Accessories	Page
Flange adapter 19665	227
Carrying case 21422	231

SPEAKER STAND

21450	BASELINE
Weight	2.35 kg
Special features	easy-to-use clamping levers; adapter sleeve 21326 included
Material	aluminum
Number of legs	3 pieces
Leg construction	tube legs with cross braces
Height adjustment	clamping lever and safety pin
Max. load capacity	50 kg
Tube end(s)	diameter 35 mm
Rod combination	2-piece folding design
Height	from 1,270 to 1,930 mm

Order No.
anodized aluminum 21450-000-30
black 21450-000-55

Accessories	Page
Carrying case 21311	230
Carrying case »Pro« 21312	231

SPEAKER STAND PACKAGE

21459	BASELINE
Weight	6.01 kg
Special features	2 x K&M Speaker Stand 21450 in a Carrying Case

Order No.
black 21459-000-55



SPEAKER STAND PACKAGE

NEW

SPEAKER STAND

SPEAKER STAND

21449	BASELINE
Weight	6.01 kg
Special features	2 x K&M speaker stand in a carrying case; easy-to-use clamping lever; patented gradual height adjustment system
Material	aluminum
Number of legs	3 pieces
Leg construction	tube legs with cross braces
Height adjustment	locking screw with push-button system
Max. load capacity	50 kg
Tube end(s)	diameter 35 mm
Rod combination	2-piece folding design
Height	from 1,270 to 1,930 mm

Order No.

black 21449-000-55

19500	TOPLINE
Weight	6.5 kg
Special features	particularly useful when space is restricted; folds flat; integrated shock absorber
Material	steel
Number of legs	4 pieces
Base diameter	950 mm
Leg construction	collapsible square tube legs
Height adjustment	spring-loaded bolt and locking screw
Max. load capacity	50 kg
Tube end(s)	diameter 35 mm
Rod combination	2-piece folding design
Size when folded	1,075 x 125 x 125 mm
Height	from 1,240 to 1,940 mm

Order No.

black 19500-011-55

Accessories

Carrying case 21311

Page

230

21435	TOPLINE
Weight	5.91 kg
Special features	patented gradual height adjustment system; integrated shock absorber; mounting aid included
Material	steel
Number of legs	3 pieces
Leg construction	tube legs with cross braces
Height adjustment	locking screw with push-button system
Max. load capacity	50 kg
Tube end(s)	diameter 35 mm
Rod combination	2-piece folding design
Height	from 1,430 to 2,240 mm

Order No.

black 21435-009-55

Accessories

Carrying case 21311

Carrying case »Pro« 21312

Page

230

231





SPEAKER STAND

21436	TOPLINE
Weight	3.5 kg
Special features	lightweight stand; patented gradual height adjustment system; integrated shock absorber; steel extension tube; mounting aid included
Material	aluminum
Number of legs	3 pieces
Leg construction	tube legs with cross braces
Height adjustment	locking screw with push-button system
Max. load capacity	40 kg
Tube end(s)	diameter 35 mm
Rod combination	2-piece folding design
Height	from 1,430 to 2,240 mm

Order No.

black 21436-009-55

Accessories

	Page
Carrying case 21311	230
Carrying case »Pro« 21312	231

SPEAKER STAND

21455	TOPLINE
Weight	3.3 kg
Special features	lightweight stand; steel extension tube; integrated shock absorber; for low to medium height applications
Material	aluminum
Number of legs	3 pieces
Leg construction	tube legs with double cross braces
Height adjustment	spring-loaded bolt and locking screw
Max. load capacity	40 kg
Tube end(s)	diameter 35 mm
Rod combination	2-piece folding design
Height	from 1,005 to 1,545 mm

Order No.

black 21455-009-55

Accessories

	Page
Carrying case 18846	142





TÜV type approved
for loads up to 50 kg

Now available in
pure white

Mounting aid



Heavy-duty aluminum stand;
World-wide classic

SPEAKER STAND

NEW

214/6	TOPLINE
Weight	4.3 kg
Special features	lightweight stand; steel extension tube; integrated shock absorber; gradual height adjustment system; zinc die-cast connecting parts; mounting aid included
Material	aluminum
Number of legs	3 pieces
Leg construction	tube legs with double cross braces
Height adjustment	spring-loaded bolt and locking screw
Max. load capacity	50 kg
Tube end(s)	diameter 35 mm
Rod combination	2-piece folding design
Height	from 1,375 to 2,185 mm

Order No.

black	21460-009-55
pure white	21460-009-76
silver	21460-009-81

All clamps are high quality zinc die-cast. The leg construction and large fixed foot end caps enhance safety and stability. This professional stand is TÜV (German Technical Supervisory Agency) approved for a maximum central load capacity of 50 kg. Other features are the pull-out guard for the extension tube, the integral anti-shock component and comfortable height adjustment with spring-loaded bolt and locking screw. Comes with a mounting aid on the extension rod.

Accessories

Accessories	Page
Carrying case 21311	230
Carrying case »Pro« 21312	231



SPEAKER STAND

26750	TOPLINE
Weight	8.34 kg
Special features	speaker will be fixed with flange adapter
Material	steel
Base diameter	450 mm
Leg construction	round cast-iron base
Height adjustment	locking screw and safety pin
Max. load capacity	35 kg
Tube end(s)	diameter 35 mm
Rod combination	2-piece folding design
Height	from 950 to 1,430 mm

Order No.

black 26750-000-55

Accessories

Page

Carrying case 21422 231
Carrier bag for round base 26751 231

SPEAKER STAND

NEW

26735	TOPLINE
Weight	10 kg
Special features	speaker will be fixed with flange adapter; mounting aid included
Material	steel
Base diameter	450 mm
Leg construction	round cast-iron base
Height adjustment	spring-loaded bolt and locking screw
Max. load capacity	20 kg
Tube end(s)	diameter 35 mm
Rod combination	2-piece folding design
Height	from 1,100 to 1,810 mm

Order No.

black 26735-000-55
pure white 26735-000-76

Accessories

Page

Carrying case 21422 231
Carrier bag for round base 26751 231





Heavy-duty stand

Easy-to-use



TÜV type approved for loads up to 50 kg.

SPEAKER STAND

213	STARLINE
Weight	8.57 kg
Special features	push-button system and hand crank avoid uncontrolled reverse motion; locking screw provides additional safety; zinc die-cast connecting parts
Material	steel
Number of legs	3 pieces
Leg construction	tube legs with double cross braces
Height adjustment	hand crank with push-button system and locking screw
Max. load capacity	50 kg
Tube end(s)	diameter 35 mm, integrated threaded bush M10 for cross-bars
Rod combination	2-piece folding design
Height	from 1,385 to 2,180 mm

Order No.

black 21300-009-55

A high quality professional speaker stand. Infinitely variable height adjustment is easy and comfortable with its hand crank system. A push-button prevents uncontrolled reverse motion. An additional locking screw guarantees extra safety. The extremely stable stand is TÜV (German Technical Supervisory Agency) approved for a maximum central weight of 50 kg.

Accessories	Page
Carrying case 21311	230
Carrying case »Pro« 21312	231

**SPEAKER STAND**

21302	STARLINE
Weight	7.65 kg
Special features	push-button system and hand crank avoid uncontrolled reverse motion; locking screw provides additional safety; plastic connecting parts
Material	steel
Number of legs	3 pieces
Leg construction	tube legs with cross braces
Height adjustment	hand crank with push-button system and locking screw
Max. load capacity	40 kg
Tube end(s)	diameter 35 mm, integrated threaded bush M10 for cross-bars
Rod combination	2-piece folding design
Height	from 1,385 to 2,180 mm

Order No.

black 21302-009-55

Accessories

Accessories	Page
Carrying case 21311	230
Carrying case »Pro« 21312	231

SPEAKER STAND WITH PNEUMATIC SPRING

21463	STARLINE
Weight	6 kg
Special features	pneumatic spring with 25 kg power, for easy and safely lift up of speakers; lightweight stand; steel extension tube; gradual height adjustment system; zinc die-cast connecting parts; mounting aid included
Material	aluminum
Number of legs	3 pieces
Leg construction	tube legs with double cross braces
Height adjustment	spring-loaded bolt and locking screw
Max. load capacity	50 kg
Tube end(s)	diameter 35 mm
Rod combination	2-piece folding design
Height	from 1,375 to 2,185 mm

Order No.

black 21463-000-55

Accessories

Accessories	Page
Carrying case 21311	230
Carrying case »Pro« 21312	231

TÜV type approved for loads up to 40 kg



Heavy-duty stand

Easy-to-use



Spring-loaded bolt and locking screw

TÜV type approved for loads up to 50 kg



Pneumatic spring with 25 kg power

p13e.k-m.de
Produktvideo



Easy-to-use ring lock system; Tight and firm fit for the speaker



TÜV type approved for loads up to 50 kg

SPEAKER STAND »RING LOCK«

21467	STARLINE
Weight	4.6 kg
Special features	further development of 214/6; lightweight stand; steel extension tube; patented expanding mandrel system »Ring Lock«; vibration-free connection due to moveable plastic splints
Material	aluminum
Number of legs	3 pieces
Leg construction	tube legs with double cross braces
Height adjustment	spring-loaded bolt and locking screw
Max. load capacity	50 kg
Tube end(s)	»Ring Lock« diameter 35 to 37 mm
Rod combination	2-piece folding design
Height	from 1,370 to 2,170 mm

Order No.

black 21467-000-55

An exceptional aluminum speaker stand with a unique patented expanding mandrel system that provides a stable, tight and firm fit for speakers. The movable plastic splints provide for a vibration-free connection between the rod and the speaker. Connecting the speaker is easy and is done using the handy ring lock - which is simply placed in position and screwed on. The height is adjusted by an easy-to-use spring-loaded bolt and locking screw. Double foot struts, zinc die cast clamping brackets and large end caps provide for highest degree of stand stability. It can't get any better than this!



SPEAKER STAND »RING LOCK« **NEW**

26737 **STARLINE**

Weight	10 kg
Special features	patented expanding mandrel system »Ring Lock«; vibration-free connection due to moveable plastic splints
Material	steel
Base diameter	450 mm
Leg construction	round cast-iron base
Height adjustment	spring-loaded bolt and locking screw
Max. load capacity	20 kg
Tube end(s)	»Ring Lock« diameter 35 to 37 mm
Rod combination	2-piece folding design
Height	from 1,125 to 1,810 mm

Order No.

black 26737-000-55

Accessories

Page

Carrying case 21422	231
Carrier bag for round base 26751	231



MONITOR STAND

26720	TOPLINE
Weight	5.35 kg
Special features	internal cable routing possible; support plate with rubber bumps; for stationary use
Material	steel
Number of legs	3 pieces
Leg construction	fixed screw-in legs
Height adjustment	locking screw and safety pin
Max. load capacity	35 kg
Rod combination	2-piece folding design
Bearing plate	245 x 205 mm
Height	from 680 to 1,140 mm

Order No.
black 26720-000-55

MONITOR STAND

26740	TOPLINE
Weight	10.16 kg
Special features	direct attachment of monitors with 3/8" threaded joint (thread length 12 mm) possible; support plate with 4 thread points and 4 rubber knobs; for stationary use
Material	steel
Base diameter	450 mm
Leg construction	round cast-iron base
Height adjustment	locking screw and safety pin
Max. load capacity	35 kg
Rod combination	2-piece folding design
Bearing plate	245 x 205 mm
Height	from 950 to 1,430 mm

Order No.
black 26740-000-55

Accessories **Page**
Carrier bag for round base 26751 231

PROJECTOR TRAY

26747	TOPLINE
Weight	3.08 kg
Special features	for projectors, monitors and for other equipment
Material	steel
Bearing plate	420 x 380 mm
Function	to slip on stand
Suitable for tubing diameter of	35 mm

Order No.
black 26747-000-55



**DESIGN MONITOR STAND**

26785	STARLINE
Weight	12.84 kg
Special features	for the Genelec 8000 monitor series; quick, uncomplicated mounting of the monitor is accomplished using the suspension device; gradual height adjustment system
Material	steel
Leg construction	cast-iron base
Height adjustment	spring-loaded clamping knob
Rod combination	2-piece folding design
Base dimensions	420 x 420 mm
Height	from 1,100 to 1,700 mm

Order No.

structured black 26785-000-56

DESIGN MONITOR STAND

26795	STARLINE
Weight	18.6 kg
Special features	gradual height adjustment system
Material	steel
Leg construction	cast-iron base
Height adjustment	spring-loaded clamping knob
Rod combination	2-piece folding design
Base dimensions	480 x 480 mm
Height	from 800 to 1,350 mm

Order No.

structured black 26795-000-56

Accessories

Bearing plate 26792

Page

218

BEARING PLATE

26792	STARLINE
Weight	4 kg
Special features	available in three different sizes; 4 spikes and 4 rubber knobs included
Material	steel
Fits	26795

Order No.

structured black, 240 x 5 26792-024-56

x 200 mm, 1,8 kg

structured black, 320 x 5 26792-032-56

x 280 mm, 3,4 kg

structured black, 420 x 5 26792-042-56

x 380 mm, 6,0 kg



ADAPTER

21329	
Weight	0.6 kg
Material	steel
Tube end(s)	threaded bush M20, threaded bolt M20
Height	250 mm

Order No.

black 21329-025-55

EXTENSION ROD

213/3	
Weight	1.76 kg
Material	steel
Tube end(s)	threaded bush M10, threaded bolt M10
Height	990 mm

Order No.

black 21330-900-55

DISTANCE ROD

21333	
Weight	0.72 kg
Material	steel
Tube end(s)	diameter 35 mm
Height	745 mm

Order No.

black 21333-000-55

Accessories

Carrying case 21421

Page

198





DISTANCE ROD

21334

Weight	1.21 kg
Special features	for precise fit
Material	steel
Tube end(s)	diameter 35 mm, threaded bolt M20

Order No.

black, 880 mm	21334-000-55
black, 500 mm	21334-050-55

Accessories

Page

Carrying case 21421	198
Connector plate 24116	226
Base plate 26700	226
Base plate 26705	226

DISTANCE ROD

21336

Weight	2.25 kg
Special features	mounting aid included
Material	steel
Height adjustment	spring-loaded bolt and locking screw
Tube end(s)	diameter 35 mm
Rod combination	2-piece folding design
Height	from 945 to 1,475 mm

Order No.

black	21336-000-55
-------	--------------

Accessories

Page

Carrying case 21421	198
---------------------	-----

DISTANCE ROD

NEW

21337

Weight	2.5 kg
Special features	for precise fit; mounting aid included
Material	steel
Height adjustment	spring-loaded bolt and locking screw
Tube end(s)	diameter 35 mm, threaded bolt M20
Rod combination	2-piece folding design
Height	from 905 to 1,450 mm

Order No.

black	21337-000-55
pure white	21337-000-76

Accessories

Page

Carrying case 21421	198
Connector plate 24116	226
Base plate 26700	226
Base plate 26705	226



DISTANCE ROD

26736	
Weight	2.85 kg
Special features	for precise fit; mounting aid included
Material	steel
Height adjustment	spring-loaded bolt and locking screw
Tube end(s)	diameter 35 mm, threaded bolt M20
Rod combination	2-piece folding design
Height	from 1,085 to 1,785 mm

Order No.

black	26736-000-55
-------	--------------

Accessories

Page

Carrying case 21422	231
Connector plate 24116	226
Base plate 26700	226
Base plate 26705	226

DISTANCE ROD WITH HAND CRANK

21338	
Weight	3.5 kg
Special features	push-button system and hand crank avoid uncontrolled reverse motion; locking screw provides additional safety
Material	steel
Height adjustment	hand crank with push-button system and locking screw
Tube end(s)	diameter 35 mm
Rod combination	2-piece folding design
Height	from 1,040 to 1,605 mm

Order No.

black	21338-000-55
-------	--------------

Accessories

Page

Carrying case 18851	142
---------------------	-----

DISTANCE ROD WITH HAND CRANK

21339	
Weight	3.98 kg
Special features	push-button system and hand crank avoid uncontrolled reverse motion; locking screw provides additional safety; M20 bolt for precise and vertical fit
Material	steel
Height adjustment	hand crank with push-button system and locking screw
Tube end(s)	diameter 35 mm, threaded bolt M20
Rod combination	2-piece folding design
Height	from 940 to 1,505 mm

Order No.

black	21339-000-55
-------	--------------

Accessories

Page

Universal carrying case 15043	75
Carrying case 18851	142
Connector plate 24116	226
Base plate 26700	226
Base plate 26705	226

Mounting aid



**DISTANCE ROD
WITH HAND CRANK AND »RING LOCK«**

21340	
Weight	3.8 kg
Special features	patented expanding mandrel system »Ring Lock«; vibration-free connection due to moveable plastic splints; push-button system and hand crank avoid uncontrolled reverse motion; locking screw provides additional safety; M20 bolt for precise and vertical fit
Material	steel
Height adjustment	hand crank with push-button system and locking screw
Tube end(s)	»Ring Lock« diameter 35 to 37 mm, threaded bolt M20
Rod combination	2-piece folding design
Height	from 920 to 1,520 mm

Order No.

black 21340-000-55

Accessories

	Page
Universal carrying case 15043	75
Carrying case 18851	142
Connector plate 24116	226
Base plate 26700	226
Base plate 26705	226



Easy-to-use ring lock system

Tight and firm fit for the speaker

DISTANCE ROD

21347	
Weight	2.19 kg
Special features	M20 bolt for precise and vertical fit
Material	steel
Height adjustment	locking screw and safety pin
Tube end(s)	diameter 35 mm, threaded bolt M20
Rod combination	2-piece folding design
Height	from 905 to 1,385 mm

Order No.

black 21347-000-55

Accessories

	Page
Carrying case 21421	198
Connector plate 24116	226
Base plate 26700	226
Base plate 26705	226

**DISTANCE ROD**

21348	
Weight	2.12 kg
Special features	with additional levelling adapter for a clearance-free fit
Material	steel
Height adjustment	locking screw and safety pin
Tube end(s)	diameter 35 mm
Rod combination	2-piece folding design
Height	from 970 to 1,490 mm

Order No.

black 21348-000-55

Accessories

	Page
Carrying case 21422	231



**DISTANCE ROD
WITH PNEUMATIC SPRING**
NEW

21356	
Weight	3.01 kg
Special features	pneumatic spring with 17 kg power, for easy and safely lift up of speakers; gradual height adjustment system; mounting aid included
Material	steel
Height adjustment	spring-loaded bolt and locking screw
Tube end(s)	diameter 35 mm
Rod combination	2-piece folding design
Height	from 1,025 to 1,545 mm

Order No.

black 21356-000-55

Accessories
Page

Carrying case 21421

198

**DISTANCE ROD
WITH PNEUMATIC SPRING**
NEW

21357	
Weight	3.01 kg
Special features	for precise fit; pneumatic spring with 17 kg power, for easy and safely lift up of speakers; gradual height adjustment system; mounting aid included
Material	steel
Height adjustment	spring-loaded bolt and locking screw
Tube end(s)	diameter 35 mm, threaded bolt M20
Rod combination	2-piece folding design
Height	from 925 to 1,445 mm

Order No.

black 21357-000-55

Accessories
Page

Carrying case 21421

198

Connector plate 24116

226

Base plate 26700

226

Base plate 26705

226

DISTANCE ROD »RING LOCK«

21360	
Weight	1.15 kg
Special features	patented expanding mandrel system »Ring Lock«; vibration-free connection due to moveable plastic splints
Material	steel
Tube end(s)	»Ring Lock« diameter 35 to 37 mm
Height	750 mm

Order No.

black 21360-000-55

Accessories
Page

Carrying case 21421

198

Mounting aid



Height adjustment with spring-loaded locking screw and safety bolt

 Integrated 17 kg
pneumatic spring

Mounting aid



Height adjustment with spring-loaded locking screw and safety bolt

 Integrated 17 kg
pneumatic spring

Easy-to-use ring lock system



Tight and firm fit for the base and satellite speaker





DISTANCE ROD »RING LOCK«

21364	
Weight	1.33 kg
Special features	patented expanding mandrel system »Ring Lock«; vibration-free connection due to moveable plastic splints; M20 bolt for precise and vertical fit
Material	steel
Tube end(s)	»Ring Lock« diameter 35 to 37 mm, threaded bolt M20
Height	880 mm

Order No.

black 21364-000-55

Accessories

Page

Carrying case 21421	198
Connector plate 24116	226
Base plate 26700	226
Base plate 26705	226

DISTANCE ROD »RING LOCK«

21366	
Weight	2.9 kg
Special features	patented expanding mandrel system »Ring Lock«; vibration-free connection due to moveable plastic splints
Material	steel
Height adjustment	spring-loaded bolt and locking screw
Tube end(s)	»Ring Lock« diameter 35 to 37 mm
Rod combination	2-piece folding design
Height	from 980 to 1,470 mm

Order No.

black 21366-014-55

Accessories

Page

Carrying case 21422	231
---------------------	-----



Easy-to-use
ring lock system



Tight and firm
fit for the satellite
speaker



DISTANCE ROD »RING LOCK«

21367

Weight	2.76 kg
Special features	patented expanding mandrel system »Ring Lock«; vibration-free connection due to moveable plastic splints; M20 bolt for precise and vertical fit
Material	steel
Height adjustment	spring-loaded bolt and locking screw
Tube end(s)	»Ring Lock« diameter 35 to 37 mm, threaded bolt M20
Rod combination	2-piece folding design
Height	from 890 to 1,380 mm

Order No.

black 21367-014-55

Unshakable and Stalwart! This high quality, height adjustable distance rod is a guarantee for a secure, stable and quiet connection to satellite systems. The height is adjusted by an easy-to-use spring-loaded bolt and locking screw. The distance rod is connected to the subwoofer using the M20 threaded bolt. The unique patented expanding mandrel system provides a stable, tight and firm fit for satellite speakers. The movable plastic splints provide for a vibration-free connection between the rod and the speaker. Connecting the speaker is easy and is done using the handy ring lock - which is simply placed in position and screwed on.

Accessories

Accessories	Page
Carrying case 21421	198
Connector plate 24116	226
Base plate 26700	226
Base plate 26705	226



DISTANCE ROD »RING LOCK«

NEW

21368	
Weight	3.2 kg
Special features	patented expanding mandrel system »Ring Lock«; vibration-free connection due to moveable plastic splints; M20 bolt for precise and vertical fit
Material	steel
Height adjustment	spring-loaded bolt and locking screw
Tube end(s)	»Ring Lock« diameter 35 to 37 mm, threaded bolt M20
Rod combination	2-piece folding design
Height	from 1,100 to 1,800 mm

Order No.

black 21368-000-55

Accessories

Page

Connector plate 24116	226
Base plate 26700	226
Base plate 26705	226

Easy-to-use ring lock system



Tight and firm fit for the satellite speaker



CONNECTOR PLATE

24116	
Weight	0.24 kg
Material	zinc die-cast
Bore holes	diameter 6.5 mm (4 x)
Function	to screw on speakers
Diameter	105 mm
Height	25 mm
Threaded connector	M20
Fits	21334, 21337, 21339, 21340, 21347, 21357, 21364, 21367, 21368, 26736

Order No.

black 24116-000-55



BASE PLATE

26700	
Weight	6.2 kg
Special features	Felt strips for floor protection are included
Material	zinc die-cast
Diameter	450 mm
Height	21 mm
Threaded connector	M20
Fits	21334, 21337, 21339, 21340, 21347, 21357, 21364, 21367, 21368, 26736

Order No.

structured black 26700-000-56

Accessories

Page

Carrier bag for round base 26751 231



BASE PLATE

NEW

26705	
Weight	13.5 kg
Special features	heavy, flat steel plate; includes a practical integrated handle and a cable management
Material	steel
Dimensions	550 x 550 x 27.3 mm
Threaded connector	M20
Fits	21334, 21337, 21339, 21340, 21347, 21357, 21364, 21367, 21368, 26736

Order No.

structured black 26705-000-56



MOUNTING ADAPTER

195/8	
Weight	0.68 kg
Material	steel
Dimensions	175 x 110 x 104 mm
Bore holes	35 x 9.5 mm (2 x)
Function	to screw on speakers, to slip on stand
Spacing of holes	from 100 to 152 mm
Suitable for tubing diameter of	35 mm

Order No.
black 19580-000-55



FLANGE ADAPTER

19654	
Weight	0.077 kg
Material	plastic
Bore holes	diameter 6.5 mm (4 x)
Function	to screw into speaker, to slip on stand
Suitable for tubing diameter of	35 mm
Installation depth	60.5 mm
Flange	diameter 105 mm

Order No.
black 19654-000-55



FLANGE ADAPTER

19656	
Weight	0.34 kg
Material	zinc die-cast
Bore holes	diameter 6.5 mm (4 x)
Function	to screw into speaker, to slip on stand
Suitable for tubing diameter of	35 mm
Installation depth	75 mm
Flange	diameter 105 mm

Order No.
black 19656-000-55



FLANGE ADAPTER

19665	
Weight	0.38 kg
Material	steel
Bore holes	diameter 6.5 mm (4 x)
Function	to screw into speaker, to slip on stand
Suitable for tubing diameter of	25 mm
Installation depth	78 mm
Flange	diameter 105 mm
Fits	21420

Order No.
black 19665-000-55



SCREW-ON ADAPTER

24281	
Weight	0.56 kg
Special features	secured by locking screw
Material	steel
Dimensions	146 x 40 x 105 mm
Bore holes	diameter 11 mm (2 x)
Function	to screw on speakers, to slip on stand
Spacing of holes	115 mm
Suitable for tubing diameter of	35 mm

Order No.
black 24281-000-55



SPEAKER TILT CONNECTOR

19670	
Weight	0.67 kg
Special features	secured by locking screws; with setting scale
Material	steel
Max. load capacity	25 kg
Height	230 mm
Angle of inclination	0° to 15°
Function	to slip on stand, to insert into speaker
Suitable for tubing diameter of	35 mm

Order No.

black 19670-000-55



Setting scale

SPEAKER TILT CONNECTOR »RING LOCK«

19674	
Weight	0.85 kg
Special features	patented expanding mandrel system »Ring Lock«; vibration-free connection due to moveable plastic splints; secured by locking screws; with setting scale
Material	steel
Max. load capacity	25 kg
Tube end(s)	»Ring Lock« diameter 35 to 37 mm
Height	300 mm
Angle of inclination	0° to 15°
Function	to slip on stand, to insert into speaker
Suitable for tubing diameter of	35 mm

Order No.

black 19674-000-55



Tight and firm fit for the speaker

Easy-to-use ring lock system

SPEAKER MOUNT

19688	
Weight	0.36 kg
Special features	to hold a JBL Control 1 speaker; incl. thread adapter 5/8" - 3/8"
Material	steel
Swivel	250°
Suitable for	3/8" and 5/8" thread

Order No.

black 19688-300-55



INCLINABLE STAND ADAPTER

19780	
Weight	0.547 kg
Special features	assembly is easy as the swivel mount is first attached to the stand and then slotted into the bracket; tiltable
Material	steel
Max. load capacity	15 kg
Height	80 mm
Angle of inclination	0° to 30°
Function	to slip on stand
Suitable for tubing diameter of	35 mm

Order No.
black 19780-000-55

ADAPTER SLEEVE »RING LOCK«

21441	
Weight	0.66 kg
Special features	patented expanding mandrel system »Ring Lock«; vibration-free connection due to moveable plastic splints; secured by locking screw
Material	steel
Tube end(s)	»Ring Lock« diameter 35 to 37 mm
Height	270 mm
Function	to slip on stand, to insert into speaker
Suitable for tubing diameter of	35 mm

Order No.
black 21441-000-55

ADAPTER SLEEVE

21326	
Weight	0.01 kg
Special features	for speaker flanges with inside tube diameter 38 mm
Material	plastic
Height	102 mm
Function	to slip on stand
Suitable for tubing diameter of	35 mm

Order No.
black 21326-000-55



Tight and firm fit for the speaker



Easy-to-use ring lock system



LEVELLING ADAPTER

85890	
Weight	0.01 kg
Special features	for distance rods; for a wobble-free fit; two adapter rings, one at each side of the rod, should be used with a satellite system
Material	plastic
Suitable for tubing diameter of	35 mm
Diameter	42 mm
Height	14.5 mm

Order No.
black (unit: 2 pcs.) 85890-000-55





SPEAKER MOUNTING FORK

24105	
Weight	1.48 kg
Special features	for 2 speakers; secured by locking screw; GS-approved for loads up to 2 x 25 kg
Material	steel
Mounting bolt	diameter 35 mm x 120 mm
Function	to slip on stand
Suitable for tubing diameter of	35 mm
Width-adjustable	from 310 to 490 mm

Order No.
black 24105-000-55



SAFETY RING

213/1	
Weight	0.117 kg
Material	aluminum
Suitable for tubing diameter of	36 mm
Diameter	52 mm
Height	35 mm

Order No.
black 21310-000-55



WARNING STRIP

21402	
Weight	0.08 kg
Special features	reflective collar; yellow/black stripes printed with „CAUTION“
Material	nylon
Dimensions	600 x 175 mm
Mounting	leg of the stand with velcro

Order No.
21402-000-00

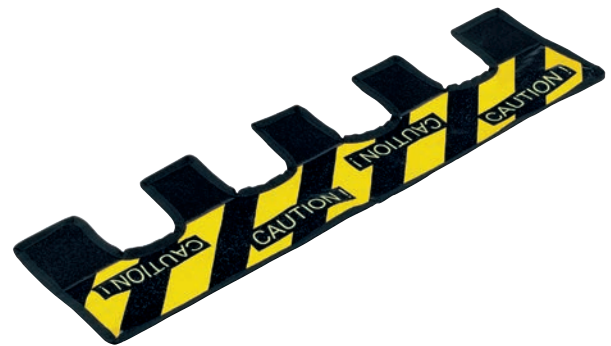

CABLE HOLDER

21403	
Weight	0.01 kg
Special features	for better cable management
Material	velours, velcro
Dimensions	220 x 25 x 1.5 mm

Order No.
black (unit: 3 pcs.) 21403-003-55



CABLE CLAMP

21404	
Weight	0.031 kg
Special features	for speaker stands & lighting stands; for up to 12 cables; 2 cable clamps are included in the delivery
Material	plastic
Dimensions diameter	61 x 16 mm
Suitable for tubing diameter of	35 to 42 mm

Order No.
black 21404-000-55

Can secure a total of 12 cables width 4 – 9 mm

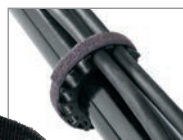

CARRYING CASE

21311	
Weight	1 kg
Special features	to store and transport two speaker/lighting stands; two inside compartments
Material	nylon
Dimensions	1,200 x 250 x 250 mm
Handle or carrying type	handle
Fastener	zip fastener
Fits	19500, 213, 21302, 214/6, 21411, 21435, 21436, 21450, 21456, 21463, 21467, 28070

Order No.
21311-000-00



CARRYING CASE »PRO«

21312	
Weight	1.32 kg
Special features	to store and transport two speaker/lighting stands; two inside compartments
Material	nylon
Dimensions	1,200 x 250 x 250 mm
Handle or carrying type	handle
Fastener	zip fastener
Fits	213, 21302, 214/6, 21411, 21435, 21436, 21450, 21456, 21463, 21467, 28070

Order No. 21312-000-00

CARRYING CASE

21422	
Weight	0.36 kg
Special features	to store and transport two speaker/monitor stands; two inside compartments
Material	nylon
Dimensions	1,290 x 140 x 140 mm
Handle or carrying type	handle
Fastener	cord fastener
Fits	20800, 21231, 21348, 21366, 21420, 26735, 26736, 26737, 26750

Order No. 21422-000-00

CARRYING CASE

24611	
Weight	1.13 kg
Special features	to store and transport two lighting/speaker stands; two inside compartments; snap fasteners adjust the sizes, 2,250 or 1,750 mm
Material	nylon
Dimensions	2,250 x 320 x 170 mm
Handle or carrying type	handle
Fastener	zip fastener
Fits	246/1, 24620, 24625, 24630, 24640

Order No. 24611-000-00



CARRIER BAG FOR ROUND BASE

26751	
Weight	0.38 kg
Material	nylon
Dimensions diameter	460 x 25 mm
Handle or carrying type	handle
Fastener	zip fastener
Suitable for	round cast-iron base diam. 450 mm
Fits	26700, 26735, 26737, 26740, 26750

Order No. 26751-000-00





SPEAKER WALL MOUNT

241	
Weight	2.74 kg
Special features	interchangeable mounting bolt
Material	steel
Max. load capacity	50 kg
Mounting bolt	diameter 35 mm x 85 mm
Wall-to-bolt clearance	420 mm
Mounting	attaches to walls

Order No.

black 24100-000-55

SPEAKER WALL MOUNT

24110	
Weight	2.7 kg
Special features	patented straddling bearing-anchors; guarantee effective clamping of speaker in any position; resonance-optimised construction
Material	steel
Max. load capacity	50 kg
Mounting bolt	straddling bearing-anchors diameter 35 to 37 mm x 85 mm
Wall-to-bolt clearance	420 mm
Mounting	attaches to walls
Angle of inclination	0° to 22°
Adjustment	gradual in 11 settings

Order No.

black 24110-000-55
white 24110-000-57



Tighten/loosen clamping element with enclosed key



GS-approved for loads up to 50 kg

SPEAKER WALL MOUNT

24120

Weight	6.1 kg
Special features	very flexible; patented straddling bearing-anchors; guarantee effective clamping of speaker in any position; resonance-optimised construction
Material	steel
Max. load capacity	50 kg
Mounting bolt	straddling bearing-anchors diameter 35 to 37 mm x 85 mm
Wall-to-bolt clearance	420 mm
Mounting	attaches to walls
Angle of inclination	0° to 22°
Swivel	180°
Adjustment	gradual in 11 settings
Wall plate	580 x 140 mm

Order No.

black 24120-000-55

The swivelling and tiltable wall mount holds your speaker at the angle you want. The mount has 11 different tilt settings moving through 22°. The swivel is adjustable to any angle. The patented expanding mandrel for loud speakers with cabinet interiors of diameter from 35 to 37 mm is tightened with a key for a non-wobble and low-resonance speaker fit.



SPEAKER WALL MOUNT

24150	
Weight	2.96 kg
Material	steel
Max. load capacity	50 kg
Mounting bolt	diameter 35 mm x 100 mm
Mounting	clamp
Swivel	180°
Wall clearance	520 mm

Order No.

black 24150-000-55

UNIVERSAL SPEAKER WALL MOUNT

24161	
Weight	0.711 kg
Material	steel
Max. load capacity	15 kg
Bearing plate	100 x 90 mm
Mounting	attaches to walls
Angle of inclination	0° to 45°
Swivel	110°
Adjustment	stepless
Wall clearance	65 mm
Ceiling mounting plate diameter	95 mm
Spacing of holes	from 70 to 76,2 mm

Order No.

structured black 24161-000-56
structured white 24161-000-66

SPEAKER WALL MOUNT

24180	
Weight	0.735 kg
Special features	small (20 x 98 mm) and wide bracket (24 x 98 mm) included
Material	steel
Max. load capacity	10 kg
Bearing plate	50 x 98.5 mm
Mounting	attaches to walls
Angle of inclination	0° to 15°
Swivel	180°
Wall clearance	105 mm
Wall plate	130 x 70 mm

Order No.

black 24180-000-55
white 24180-000-57



GS-approved for loads up to 50 kg



Flexible and compact.
For loud speakers up to 15 kg.



GS-approved for loads up to 10 kg

SPEAKER WALL/ CEILING MOUNT

24185	
Weight	0.7 kg
Special features	also suitable as ceiling mount
Material	steel
Max. load capacity	8 kg
Bearing plate	95 x 80 mm
Mounting	attaches to walls and ceilings
Angle of inclination	0° to 90°
Swivel	360°
Adjustment	swivel ball joint assembly
Wall clearance	175 mm
Wall plate	95 x 95 mm

Order No.

black	24185-000-55
black, without bearing plate, instead with 3/8" threaded connector	24185-300-55

SPEAKER WALL / CEILING MOUNT

24195	
Weight	1.08 kg
Special features	also suitable as ceiling mount; steel safety wire cable included
Material	steel
Max. load capacity	15 kg
Bearing plate	127 x 60 mm
Mounting	attaches to walls and ceilings
Angle of inclination	0° to 90°
Swivel	360°
Adjustment	tooth system with wing nut
Wall clearance	271 mm
Wall plate	170 x 95 mm

Order No.

black	24195-000-55
-------	--------------

SPEAKER WALL MOUNT

24465	
Weight	0.6 kg
Special features	to hold a JBL Control 1 speaker
Material	steel
Mounting	attaches to walls
Angle of inclination	0° to 90°
Swivel	85°
Wall clearance	153 mm
Wall plate	120 x 85 mm

Order No.

black	24465-000-55
white	24465-000-57



GS-approved for loads up to 8 kg



**SPEAKER WALL MOUNT****24471**

Weight	0.87 kg
Special features	easy mounting by convenient hooking in and screw locking; swivelling and tiltable
Material	steel
Max. load capacity	15 kg
Mounting	attaches to walls
Angle of inclination	0° to 30°
Swivel	90°
Wall clearance	110 mm
Wall plate	160 x 90 mm

Order No.

black	24471-000-55
white	24471-000-57

Accessories**Page**

Adapter panel 1 24352	237
Adapter panel 2 24354	237
Adapter panel 3 24356	237
Adapter panel 4 24357	237
Adapter panel 5 24358	237
Adapter panel 6 24359	237

SPEAKER WALL MOUNT**24481**

Weight	1.34 kg
Special features	easy mounting by convenient hooking in and screw locking; swivelling and tiltable; large wall plate for heavy speakers
Material	steel
Max. load capacity	25 kg
Mounting	attaches to walls
Angle of inclination	0° to 30°
Swivel	90°
Wall clearance	110 mm
Wall plate	220 x 120 mm

Order No.

black	24481-000-55
white	24481-000-57

Accessories**Page**

Adapter panel 1 24352	237
Adapter panel 2 24354	237
Adapter panel 3 24356	237
Adapter panel 4 24357	237
Adapter panel 5 24358	237
Adapter panel 6 24359	237

SPEAKER CEILING MOUNT**NEW****24496**

Weight	1.79 kg
Special features	internal cable management; easy mounting by convenient hooking in and screw locking
Material	steel
Bearing plate	90 x 47 mm
Mounting	attaches to ceilings
Angle of inclination	0° to 45°
Swivel	90°
Adjustment	stepless
Ceiling clearance	250 mm
Ceiling mounting plate	160 x 118 mm
Spacing of holes	from 70 to 76,2 mm

Order No.

black	24496-000-55
white	24496-000-57

Accessories**Page**

Adapter panel 1 24352	237
Adapter panel 2 24354	237
Adapter panel 3 24356	237
Adapter panel 4 24357	237
Adapter panel 5 24358	237
Adapter panel 6 24359	237



ADAPTER PANEL 1

NEW

24352

Weight	0.33 kg
Special features	mounting templates: 69,9 x 127 mm - M8 50,8 x 107,9 mm - M6 62 x 47 mm - M6 70 to 76,2 mm - M6
Material	steel
Bearing plate	95 x 150 mm
Fits	24471, 24481, 24496

Order No.

black	24352-000-55
white	24352-000-57



ADAPTER PANEL 2

NEW

24354

Weight	0.33 kg
Special features	mounting templates: 127 x 69,9 mm - M8 107,9 x 50,8 mm - M6 70 bis 76,2 mm - M6
Material	steel
Bearing plate	150 x 95 mm
Fits	24471, 24481, 24496

Order No.

black	24354-000-55
white	24354-000-57



ADAPTER PANEL 3

NEW

24356

Weight	0.22 kg
Special features	mounting template: 50.8 x 107.9 mm - M6
Material	steel
Bearing plate	71 x 128 mm
Fits	24471, 24481, 24496

Order No.

black	24356-000-55
white	24356-000-57



ADAPTER PANEL 4

NEW

24357

Weight	0.24 kg
Special features	mounting template: 107.9 x 50.8 mm - M6
Material	steel
Bearing plate	128 x 90 mm
Fits	24471, 24481, 24496

Order No.

black	24357-000-55
white	24357-000-57



ADAPTER PANEL 5

NEW

24358

Weight	0.145 kg
Special features	mounting template: 115 mm - M10
Material	steel
Bearing plate	40 x 145 mm
Fits	24471, 24481, 24496

Order No.

black	24358-000-55
white	24358-000-57



ADAPTER PANEL 6

NEW

24359

Weight	0.14 kg
Special features	mounting template: 70 to 76.2 mm - M6
Material	steel
Bearing plate	90 x 100 mm
Fits	24471, 24481, 24496

Order No.

black	24359-000-55
white	24359-000-57



Including locking screws for the Genelec 8000 series



SPEAKER WALL MOUNT

24484

Weight	1.525 kg
Special features	easy mounting by convenient hooking in and screw locking; swivelling and tiltable; screws and keys are included; suitable for JBL Series LSR 2328 P, 2325 P, 4328 P and 4326 P
Material	steel
Max. load capacity	20 kg
Mounting	attaches to walls
Angle of inclination	0° to 30°
Swivel	120°
Wall clearance	404 mm
Wall plate	90 x 160 mm

Order No.

black 24484-000-55

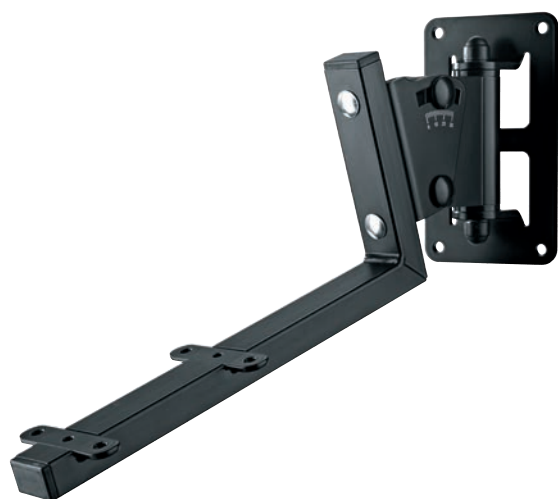

LIGHTING STAND

24620	BASELINE
Weight	3.66 kg
Special features	lightweight stand; aluminum crossbar with boreholes for up to 8 spotlights included
Material	aluminum
Number of legs	3 pieces
Leg construction	tube legs with cross braces
Height adjustment	clamping lever and safety pin
Max. load capacity	20 kg
Tube end(s)	diameter 35 mm
Rod combination	2-piece folding design
Height	from 1,750 to 3,000 mm
Crossbar dimensions	diameter 35 x 1,230 mm

Order No.

black anodized 24620-000-35

Accessories

	Page
Carrying case 24611	231
Screw fitting set 24621	244

LIGHTING STAND

24625	BASELINE
Weight	2.71 kg
Special features	lightweight stand; with adapter to take a TV pin (inner extension tube diameter 28 mm)
Material	aluminum
Number of legs	3 pieces
Leg construction	tube legs with cross braces
Height adjustment	clamping lever and safety pin
Max. load capacity	20 kg
Tube end(s)	diameter 35 mm
Rod combination	2-piece folding design
Height	from 1,800 to 3,220 mm

Order No.

black anodized 24625-000-35

Accessories

	Page
Carrying case 24611	231
Crossbar 24622	243

LIGHTING STAND

24630	TOPLINE
Weight	7.11 kg
Material	steel
Number of legs	3 pieces
Leg construction	tube legs with cross braces
Height adjustment	locking screw with push-button system
Max. load capacity	20 kg
Tube end(s)	diameter 35 mm, integrated threaded bush M10 for crossbars
Rod combination	2-piece folding design
Height	from 1,955 to 2,915 mm

Order No.

black 24630-009-55

Accessories

	Page
Crossbar 213/9	243
Crossbar 21393	243
Side crossbar 24637	243
Crossbar 24622	243
Carrying case 24611	231



With adapter to take a TV pin



LIGHTING STAND

24640	TOPLINE
Weight	12.68 kg
Special features	adjustable up to 4 m; additional safety rings
Material	steel
Number of legs	3 pieces
Leg construction	tube legs with double cross braces
Height adjustment	non-scratching locking screws
Max. load capacity	20 kg
Tube end(s)	diameter 30 mm, integrated threaded bush M10 for crossbars
Rod combination	3-piece folding design
Height	from 1,590 to 4,025 mm

Order No.

black 24640-009-55

Accessories

	Page
Crossbar 213/9	243
Carrying case 24611	231





LIGHTING STAND

NEW**24624****STARLINE**

Weight	17.4 kg
Special features	integrated shock absorber; gradual height adjustment system; zinc die-cast connecting parts
Material	steel
Leg construction	flat steel plate
Height adjustment	spring-loaded bolt and locking screw
Max. load capacity	18 kg
Tube end(s)	diameter 35 mm, integrated threaded bush M10 for crossbars
Rod combination	2-piece folding design
Base dimensions	550 x 550 mm
Height	from 1,400 to 2,400 mm

Order No.

black

24624-000-55

Attractive lighting stand. Thanks to the heavy, flat steel plate the stand is well suited for use in small areas. The proven safety bolt with locking screw provides for comfortable and safe height adjustment. The stand's maximum extension height is 2400 mm and maximum weight is 18 kg. The integrated M10 threaded bushing provides for the attachment of crossbars.



TÜV type approved for loads up to 30 kg

LIGHTING/SPEAKER STAND

246/1	STARLINE
Weight	8.14 kg
Special features	steel extension tube; push-button system and hand crank avoid uncontrolled reverse motion; locking screw provides additional safety; zinc die-cast connecting parts
Material	aluminum
Number of legs	3 pieces
Leg construction	tube legs with double cross braces
Height adjustment	hand crank with push-button system and locking screw
Max. load capacity	30 kg
Tube end(s)	diameter 35 mm, integrated threaded bush M10 for crossbars
Rod combination	2-piece folding design
Height	from 1,865 to 3,040 mm

Order No.

black 24610-009-55

High quality lighting stand for professional use. New die-cast zinc clamps and the larger aluminum leg tubing enhance safety. Height adjustment to any height is by means of a hand crank and push button system. The integrated M10 thread adaptor can be used to attach crossbars 213/9 and 21393.

Accessories	Page
Crossbar 213/9	243
Crossbar 21393	243
Carrying case 24611	231



FLOOR STAND FOR SPOT LIGHTS

NEW

17725	
Weight	0.7 kg
Special features	with threaded bolt M10
Material	steel
Base diameter	252 mm
Height	50 mm

Order No.
black 17725-000-55



FLOOR STAND FOR SPOT LIGHTS

NEW

17720	
Weight	0.7 kg
Special features	with mini TV mount
Material	steel
Base diameter	352 mm
Height	68 mm

Order No.
black 17720-000-55



CROSSBAR

213/9	
Weight	2.14 kg
Special features	M10 x 40 mm bolt and washer included
Material	steel
Dimensions	1,260 x 40 x 20 mm
Takes up to	10 spot lights
Suitable for	M10 thread
Fits	246/1, 24630, 24640

Order No.
black 21390-000-55

Accessories	Page
Screw fitting set 21394	244



CROSSBAR

21393	
Weight	2.92 kg
Special features	secured by locking screw; 4 screw fittings included
Material	steel
Dimensions	1,455 x 40 x 20 mm
Takes up to	10 spot lights
Suitable for	tube diameter 35 mm
Fits	246/1, 24630

Order No.
black 21393-070-55

Accessories	Page
Screw fitting set 21394	244

CROSSBAR

24622	
Weight	0.65 kg
Special features	secured by locking screw
Material	aluminum
Max. load capacity	20 kg
Dimensions diameter	36 x 1,230 mm
Takes up to	8 spot lights
Suitable for	tube diameter 35 mm
Fits	24625, 24630

Order No.
black anodized 24622-000-35

Accessories	Page
Screw fitting set 24621	244

SIDE CROSSBAR

24637	
Weight	0.6 kg
Material	aluminum
Dimensions diameter	36 x 665 mm
Takes up to	4 spot lights
Suitable for	tube diameter 35 mm
Fits	24630

Order No.
black 24637-000-55





SCREW FITTING SET

21394

Weight	0.36 kg
Special features	for crossbars
Dimensions diameter	50 x 45 mm
Quantity	4 screw fittings
Fits	213/9, 21393

Order No.

black (unit: 4 pcs.) 21394-000-55

SCREW FITTING SET

24621

Weight	0.3 kg
Dimensions diameter	54 x 51 mm
Quantity	4 screw fittings
Fits	24620, 24622

Order No.

black (unit: 4 pcs.) 24621-000-55

TV PIN

24516

Weight	0.02 kg
Material	aluminum
Diameter	16 mm
Length	46.5 mm
Threaded connector	male thread M10 x 17 mm

Order No.

blank 24516-000-00



TV PIN

24518

Weight	0.48 kg
Material	steel
Diameter	35 mm
Length	215 mm
Threaded connector	female thread M10 x 35 mm

Order No.

zinc-plated 24518-000-29

TV PIN

24519

Weight	0.478 kg
Material	steel
Diameter	28 mm
Length	115 mm
Threaded connector	female thread M10 x 34 mm

Order No.

zinc-plated 24519-000-29

REDUCER FLANGE

24521

Weight	0.52 kg
Special features	secured by locking screw
Material	steel
Function	to slip on stand
Suitable for tubing diameter of	35 mm
Diameter	40 mm
Length	100 mm

Order No.

black, M10 x 12 mm 24521-000-55
 black, M6 x 18 mm 24521-060-55
 black, M8 x 18 mm 24521-070-5f5
 black, bolt diameter 25 mm 24521-250-55
 black, 3/8" x 12 mm 24521-300-55



REDUCER FLANGE

24528	
Weight	0.46 kg
Special features	secured by locking screw
Material	steel
Function	to slip on stand
Suitable for tubing diameter of	35 mm
Diameter	40 mm
Length	100 mm
Threaded connector	M10

Order No.

black 24528-000-55

CONNECTION SLEEVE

66350	
Weight	0.66 kg
Special features	for TV-pin diameter 28 mm; with threaded bolt M10 x 20 mm; T-bar locking screw
Material	steel
Function	to slip on stand
Suitable for tubing diameter of	35 mm
Diameter	40 mm
Length	249 mm
Threaded connector	M10

Order No.

black 66350-070-55







MULTIMEDIA EQUIPMENT

The growing market for multimedia products has in turn sparked a steadily climbing demand for holders and stands for diverse purposes.

For example, monitors of all shapes and sizes need to be mounted on shop ceilings, on the walls of trade fair stands, or presented on stands in entrances.

König & Meyer offers flexible holders and stands for nearly every purpose in unmistakable designs and the usual high-quality workmanship.



LECTERN »OVATION PRO«

12386	
Weight	15.4 kg
Special features	acoustic insulation (shock-mount plates effectively absorb shock and vibrations)
Material	stand aluminum, wooden desk with aluminum finish
Size when folded	1,170 x 250 x 620 mm
Base dimensions	810 x 700 mm
Connection	two 3-pin XLR microphone sockets
Height	1,340 mm
Sloping desktop	620 x 462 mm
Level top	550 x 134 mm

Order No.

silver	12386-000-81
--------	--------------

Accessories	Page
Promotional board 12383	248
Protective cover 12387	248
Transportation case (hard case) 12388	249

PROMOTIONAL BOARD (EXCL. LOGO)

12383	
Weight	1.78 kg
Special features	quick mounting and removal with two locking screws, no tools required optional: foil lettering to customer specifications
Material	aluminum
Dimensions	480 x 230 mm
Fits	12380, 12386

Order No.

silver	12383-000-81
--------	--------------

PROTECTIVE COVER FOR LECTERN

12387	
Weight	3.66 kg
Special features	foamed cover
Material	nylon
Handle or carrying type	handle and shoulder straps
Fastener	zip fastener
Fits	12380, 12386

Order No.

	12387-000-00
--	--------------



**TRANSPORTATION CASE
(HARD CASE) FOR LECTERN**

12388	
Weight	15.58 kg
Special features	with aluminum edges and casters; foamed compartments for housing the folded lectern and accessories
Material	plastic
Dimensions	1,265 x 685 x 305 mm
Thickness	7 mm
Fits	12380, 12386

Order No.
12388-000-00

UNIVERSAL TABLE-TOP STAND

12140	
Weight	1.267 kg
Special features	suitable for notebooks, multimedia equipment, books, sheet music, etc.; 4 rubber knobs included
Material	steel stand, aluminum desk
Leg construction	U-profile legs snap into socket
Max. load capacity	4 kg
Connection stand/plate	prismatic »V-block« connector
Bearing plate	350 x 273 mm
Height	240 mm

Order No.
black 12140-000-55

LAPTOP STAND

12180	
Weight	2.1 kg
Special features	soft caps; 4 rubber pads included
Material	steel
Size when folded	440 x 370 x 35 mm
Dimensions	300 x 350 x 300 mm
Angle of inclination	0° to 33°
Adjustment	tilt gradual in 5 settings

Order No.
black 12180-013-55

Prismatic »V-block« Connector



Can be inclined to 5 different angles



LAPTOP STAND

12155

Weight	3.18 kg
Special features	4 rubber knobs included
Material	steel, plastic base
Leg construction	socket with foldable legs
Max. load capacity	5 kg
Rod combination	2-piece folding design
Connection stand/plate	prismatic »V-block« connector
Height	from 780 to 1,290 mm
Laptop rest	400 x 290 mm

Order No.

black 12155-000-55

Accessories

Page

Carrying case 11450 44



Folds compactly





Screw-on mouse rest

LAPTOP STAND

12150	
Weight	4 kg
Special features	mouse pad and 4 rubber knobs included
Material	steel
Leg construction	U-profile legs with cross braces
Max. load capacity	10 kg
Rod combination	2-piece folding design
Connection stand/plate	prismatic »V-block« connector
Height	from 710 to 1,210 mm
Laptop rest	400 x 290 mm
Mouse rest	245 x 195 mm

Order No.

black 12150-000-55

This laptop stand is perfect for many occasions, whether used in presentations or simply as a work station. The ergonomically designed clamping elements allow easy and fast height adjustment. The separate mouse rest can be attached as required. The large laptop rest is easy and fast to connect to the stand with the prismatic »V-block« connector.

Accessories

Page

Carrying case 11450

44





Easy to set up - hooking in system for screens

SCREEN/MONITOR STAND

26782	
Weight	17.12 kg
Special features	internal cable routing possible; installation material (M4/M6/M8) and assembly tools included
Material	steel
Leg construction	cast-iron base
Rod combination	2-piece folding design
Height	from 1,100 to 1,650 mm
Mounting device	VESA MIS-D 100 (100x100) - ground plate, VESA MIS-E 200 (200x100) - ground plate, VESA MIS-E 200 (100x200) - with adapter bars, VESA MIS-F 200 (200x200) - with adapter bars, VESA MIS-F - with universal bracket: 250 to 600 mm horizontal 150 to 400 mm vertical
Height adjustment	spring-loaded clamping knob
Suitable for	flat screens from 24" to 46"
Base dimensions	420 x 420 mm

Order No.

structured black 26782-000-56

A representative screen/monitor stand with a beautifully designed heavy cast iron base. The assembly accessories provided with the product allow one to set up according to the VESA Standard for 24" to 46" flat screens. The large tubing saves space by providing a place to organize and store the cables. The height can be adjusted in steps using an ergonomic height adjustment screw.

SCREEN/MONITOR STAND

26783	
Weight	17.7 kg
Special features	internal cable routing possible; installation material (M6/M8) and assembly tools included
Material	steel
Leg construction	Legs constructed from steel profile tubes with adjustable leveling feet ensure that the setup does not rock
Rod combination	2-piece folding design
Height	from 1,100 to 1,650 mm
Mounting device	VESA MIS-F - with universal bracket: 300 to 800 mm horizontal, 200 to 500 mm vertical
Height adjustment	spring-loaded clamping knob
Suitable for	flat screens from 42" to 65"
Base dimensions	900 x 500 mm

Order No.

structured black 26783-000-56

iPad STAND

19772	
Weight	2.64 kg
Special features	iPad is easily clipped into the holder; dock-connector and headphone jack are accessible; freely rotates 90°; suitable for iPad 2nd, 3rd or 4th generation
Material	plastic, steel
Max. load capacity	1 kg
Bearing plate	252.1 x 195.4 mm
Height	from 700 to 1,550 mm
Angle of inclination	0° to 90°
Swivel	90°
Adjustment	stepless

Order No.

black 19772-300-55

iPad Air STAND

19774	
Weight	2.075 kg
Special features	iPad Air is easily clipped into the holder; lightning connector and headphone jack are accessible; freely rotates 90°; suitable for iPad Air
Material	plastic, steel
Max. load capacity	1 kg
Bearing plate	249 x 178.7 mm
Height	from 700 to 1,550 mm
Angle of inclination	0° to 90°
Swivel	90°
Adjustment	stepless

Order No.

black 19774-300-55



Swiveling in all directions.

Switches rapidly between the vertical and horizontal format without slipping.



p10e.k-m.de
Product video

iPad Air 2 STAND

NEW

19777

Weight	2.075 kg
Special features	iPad Air 2 is easily clipped into the holder; lightning connector and headphone jack are accessible; freely rotates 90°; suitable for iPad Air 2
Material	plastic, steel
Max. load capacity	1 kg
Bearing plate	249 x 178.7 mm
Height	from 700 to 1,550 mm
Angle of inclination	0° to 90°
Swivel	90°
Adjustment	stepless

Order No.

black 19777-300-55

TABLET PC STAND

19776

Weight	1.8 kg
Special features	also suitable for tablets in cases or protective covers; adjustable clamping jaws ensure unhindered access to the interfaces and the operating elements on the device; freely rotates 90°
Material	plastic, steel
Max. load capacity	1 kg
Height	from 650 to 1,500 mm
Length	from 160 to 320 mm
Angle of inclination	0° to 90°
Swivel	90°
Adjustment	stepless

Order No.

black 19776-300-55

SMARTPHONE STAND

NEW

19850

Weight	0.072 kg
Special features	gentle grip pads
Material	acrylic
Dimensions	75 x 50 x 85 mm

Order No.

black 19850-000-55



Swiveling in all directions.

Switches rapidly between the vertical and horizontal format without slipping.



p10e.k-m.de
Product video

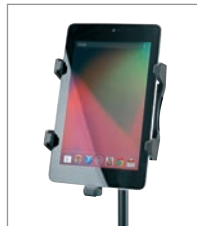

p12e.k-m.de
Product video



TABLET-PC STAND

NEW

19855	
Weight	0.194 kg
Special features	gentle grip pads
Material	acrylic
Dimensions	130 x 80 x 140 mm

Order No.

black 19855-000-55

iPad mini TABLE STAND

19760	
Weight	0.99 kg
Special features	iPad mini is easily clipped into the holder; lightning connector and headphone jack are accessible; freely rotates 90°; suitable for iPad mini or iPad mini with Retina display
Material	plastic, steel
Max. load capacity	0.75 kg
Bearing plate	208.7 x 143.7 mm
Angle of inclination	0° to 90°
Swivel	90°
Adjustment	stepless

Order No.

black 19760-000-55

iPad TABLE STAND

19752	
Weight	1.3 kg
Special features	iPad is easily clipped into the holder; dock-connector and headphone jack are accessible; freely rotates 90°; suitable for iPad 2nd, 3rd or 4th generation
Material	plastic, steel
Max. load capacity	0.75 kg
Bearing plate	252.1 x 195.4 mm
Angle of inclination	0° to 90°
Swivel	90°
Adjustment	stepless

Order No.

black 19752-000-55



iPad Air TABLE STAND

19754

Weight	1.295 kg
Special features	iPad Air is easily clipped into the holder; lightning connector and headphone jack are accessible; freely rotates 90°; suitable for iPad Air
Material	plastic, steel
Max. load capacity	0.75 kg
Bearing plate	249 x 178.7 mm
Angle of inclination	0° to 90°
Swivel	90°
Adjustment	stepless

Order No.

black 19754-000-55



Swiveling in all directions.

Switches rapidly between the vertical and horizontal format without slipping.



iPad Air 2 TABLE STAND

NEW

19757

Weight	1.295 kg
Special features	iPad Air 2 is easily clipped into the holder; lightning connector and headphone jack are accessible; freely rotates 90°; suitable for iPad Air 2
Material	plastic, steel
Max. load capacity	0.75 kg
Bearing plate	249 x 178.7 mm
Angle of inclination	0° to 90°
Swivel	90°
Adjustment	stepless

Order No.

black 19757-000-55

Strength and stability! The mobile table stand for your iPad Air 2. The iPad Air 2 is held safely and securely thanks to the sturdy steel base. With this high-quality table stand, you can easily read, write, surf the Internet or just view pictures or videos without any vibrations. The iPad Air 2 clips in and out of the holder effortlessly. An easy-to-use wing nut adjusts the tilt so that every user can adapt the viewing angle to suit them optimally. The iPad Air 2 can be rapidly switched between the vertical and horizontal format without slipping.

Swiveling in all directions.

Switches rapidly between the vertical and horizontal format without slipping.



iPad mini WALL MOUNT

19733	
Weight	0.106 kg
Special features	iPad mini is easily clipped into the holder; lightning connector and headphone jack are accessible; freely rotatable by 360°; suitable for iPad mini or iPad mini with Retina display
Material	plastic
Max. load capacity	0.75 kg
Bearing plate	208.7 x 143.7 mm
Mounting	attaches to walls
Swivel	360°

Order No.
black 19733-000-55

iPad WALL MOUNT

19732	
Weight	0.43 kg
Special features	iPad is easily clipped into the holder; dock-connector and headphone jack are accessible; freely rotatable by 360°; suitable for iPad 2nd, 3rd or 4th generation
Material	plastic
Max. load capacity	0.75 kg
Bearing plate	252.1 x 195.4 mm
Mounting	attaches to walls
Swivel	360°

Order No.
black 19732-000-55

iPad Air WALL MOUNT

19734	
Weight	0.275 kg
Special features	iPad Air is easily clipped into the holder; lightning connector and headphone jack are accessible; freely rotatable by 360°; suitable for iPad Air
Material	plastic
Max. load capacity	0.75 kg
Bearing plate	249 x 178.7 mm
Mounting	attaches to walls
Swivel	360°

Order No.
black 19734-000-55



Once attached, the iPad turns comfortably 360° and won't slip.

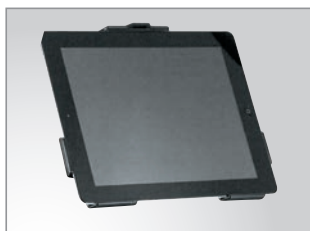

p10e.k-m.de
Product video

iPad Air 2 WALL MOUNT

NEW

19737

Weight	0.229 kg
Special features	iPad Air 2 is easily clipped into the holder; lightning connector and headphone jack are accessible; freely rotatable by 360°; suitable for iPad Air 2
Material	plastic
Max. load capacity	0.75 kg
Bearing plate	249 x 178.7 mm
Mounting	attaches to walls
Swivel	360°

Order No.

black 19737-000-55



Once attached, the iPad Air 2 turns comfortably 360° and won't slip.



p10e.k-m.de
Product video

iPad is a trademark of Apple Inc.



SMARTPHONE HOLDER

NEW

iPad mini HOLDER

iPad HOLDER

19745	
Weight	0.19 kg
Special features	to be attached to tubes up to 30 mm diameter; particularly suitable for smartphones, flat devices and MP3 players; operating elements are not impaired in their function; freely rotates 90°; flexible holding arm for individual alignment
Material	plastic
Length	from 44 to 84 mm
Screw-on to	tube diameter up to 30 mm

Order No.

black 19745-015-55

19723	
Weight	0.63 kg
Special features	to be attached to tubes up to 30 mm diameter; iPad mini is easily clipped into the holder; lightning connector and headphone jack are accessible; freely rotates 90°; alternatively: can be screwed on to 3/8" thread connectors; suitable for iPad mini or iPad mini with Retina display
Material	plastic
Max. load capacity	0.75 kg
Bearing plate	208.7 x 143.7 mm
Screw-on to	tube diameter up to 30 mm
Swivel	90°

Order No.

black 19723-000-55

19722	
Weight	0.89 kg
Special features	to be attached to tubes up to 30 mm diameter; iPad is easily clipped into the holder; dock-connector and headphone jack are accessible; freely rotates 90°; alternatively: can be screwed on to 3/8" thread connectors; suitable for iPad 2nd, 3rd or 4th generation
Material	plastic
Max. load capacity	0.75 kg
Bearing plate	252.1 x 195.4 mm
Screw-on to	tube diameter up to 30 mm
Swivel	90°

Order No.

black 19722-000-55

Suitable for flat devices, e.g. smartphones or MP3 players



The iPad switches rapidly between the vertical and horizontal format without slipping.



p10e.k-m.de
Product video

iPad Air HOLDER

19724	
Weight	0.65 kg
Special features	to be attached to tubes up to 30 mm diameter; iPad Air is easily clipped into the holder; lightning connector and headphone jack are accessible; freely rotates 90°; alternatively: can be screwed on to 3/8" thread connectors; suitable for iPad Air
Material	plastic, steel
Max. load capacity	0.75 kg
Bearing plate	249 x 178.7 mm
Screw-on to	tube diameter up to 30 mm
Swivel	90°

Order No.

black 19724-000-55

iPad Air 2 HOLDER

NEW

19727	
Weight	0.65 kg
Special features	to be attached to tubes up to 30 mm diameter; iPad Air 2 is easily clipped into the holder; lightning connector and headphone jack are accessible; freely rotates 90°; alternatively: can be screwed on to 3/8" thread connectors; suitable for iPad Air 2
Material	plastic, steel
Max. load capacity	0.75 kg
Bearing plate	249 x 178.7 mm
Screw-on to	tube diameter up to 30 mm
Swivel	90°

Order No.

black 19727-000-55



Swiveling in all directions.

Switches rapidly between the vertical and horizontal format without slipping.



p10e.k-m.de
Product video



Suitable for attaching tablet PCs in size from 120 to 220 mm



p12e.k-m.de
Produktvideo



TABLET PC HOLDER

19740

Weight	0.79 kg
Special features	to be attached to tubes up to 30 mm diameter; also suitable for tablets in cases or protective covers; adjustable clamping jaws ensure unhindered access to the interfaces and the operating elements on the device; freely rotates 90°; alternatively: can be screwed on to 3/8" thread connectors
Material	plastic
Height	from 120 to 220 mm
Length	from 160 to 320 mm
Screw-on to	tube diameter up to 30 mm
Swivel	90°
Adjustment	tension spring

Order No.

black 19740-000-55

A distinctive tensioning mechanism means this holder is suitable for attaching tablet PCs like iPad, iPad Air, iPad mini, Amazon Kindle, Samsung Galaxy Tab, Google Nexus, Asus Transformer or Microsoft Surface in size from 120 to 220 mm to a shaft diameter of max. 30 mm. The holder is equally suitable for tablets with a protective sleeve or case. A tension spring allows the tablet to be clipped in and removed from the holder easily and quickly. The holder does not affect the functioning of the operating controls. The felt-protected adjustable bracket provides extra security. The tablet holder can of course be switched between portrait and landscape format and potential slippage is prevented.

iPad mini STAND HOLDER

19713	
Weight	0.3 kg
Special features	to be screwed on to 3/8" threaded bolts; iPad mini is easily clipped into the holder; lightning connector and headphone jack are accessible; freely rotates 90°; suitable for iPad mini or iPad mini with Retina display
Material	plastic
Max. load capacity	0.75 kg
Bearing plate	208.7 x 143.7 mm
Suitable for	3/8" thread
Swivel	90°
Fits	18817, 19715

Order No.
black 3/8" 19713-300-55

iPad STAND HOLDER

19712	
Weight	0.5 kg
Special features	to be screwed on to 3/8" threaded bolts; iPad is easily clipped into the holder; dock-connector and headphone jack are accessible; freely rotates 90°; suitable for iPad 2nd, 3rd or 4th generation
Material	plastic
Max. load capacity	0.75 kg
Bearing plate	252.1 x 195.4 mm
Suitable for	3/8" thread
Swivel	90°
Fits	18817, 19715

Order No.
black 3/8" 19712-300-55

iPad Air STAND HOLDER

19714	
Weight	0.38 kg
Special features	to be screwed on to 3/8" threaded bolts; iPad Air is easily clipped into the holder; lightning connector and headphone jack are accessible; freely rotates 90°; suitable for iPad Air
Material	plastic
Max. load capacity	0.75 kg
Bearing plate	249 x 178.7 mm
Suitable for	3/8" thread
Swivel	90°
Fits	18817, 19715

Order No.
black 3/8" 19714-300-55



For stands ...

... and boom arms



Switches rapidly between the vertical and horizontal format without slipping. Adjustable tilt.



p10e.k-m.de
Product video

iPad Air 2 STAND HOLDER

NEW

TABLET PC STAND HOLDER

ADAPTER FOR SCREENS

19717	
Weight	0.38 kg
Special features	to be screwed on to 3/8" threaded bolts; iPad Air 2 is easily clipped into the holder; lightning connector and headphone jack are accessible; freely rotates 90°; suitable for iPad Air 2
Material	plastic
Max. load capacity	0.75 kg
Bearing plate	249 x 178.7 mm
Suitable for	3/8" thread
Swivel	90°
Fits	18817

Order No.
black 3/8" 19717-300-55

19742	
Weight	0.42 kg
Special features	to be screwed on to 3/8" threaded bolts; also suitable for tablets in cases or protective covers; adjustable clamping jaws ensure unhindered access to the interfaces and the operating elements on the device; freely rotates 90°
Material	plastic
Height	from 120 to 220 mm
Length	from 160 to 320 mm
Suitable for	3/8" thread
Swivel	90°
Fits	18817, 19715

Order No.
black 3/8" 19742-300-55

19685	
Weight	0.62 kg
Special features	prismatic »V-block« connector swivel joint with wing nut attaches to mic stands
Material	steel
Max. load capacity	5 kg
Bearing plate	115 x 115 mm
Mounting device	4 mount holes VESA 75/100
Suitable for	3/8" thread
Swivel	250°

Order No.
black 19685-300-55

Switches rapidly between the vertical and horizontal format without slipping.

Adjustable tilt.



Suitable for attaching tablet PCs in size from 120 to 220 mm



For stands and boom arms



p12e.k-m.de
Product video

Prismatic »V-block« Connector



p10e.k-m.de
Product video

**SHOULDER BAG
FOR SHEET MUSIC AND TABLETS**

19705

Weight	0.68 kg
Special features	for sheet music, tablets, netbooks and ultrabooks up to max. 13.3"
Material	imitation leather
Dimensions	365 x 75 x 300 mm
Handle or carrying type	shoulder strap
Fastener	zip fastener

Order No.

black 19705-000-00

Many compartments providing order and easy access



K&M KÖNIG & MEYER
Stands For Music



SHOP FITTINGS

The brand-compatible presentation of products in a shop is playing an increasingly important role in the buying decision process.

Clear and visually appealing, the large selection of König & Meyer instrument holders in combination with the professional SPACEWALL shop fitting system are a perfect solution for your business.

The flexible SPACEWALL wall panels can be installed in practically any texture or colour you desire in any shop. They will show off your merchandise perfectly, whether you have a small showroom or a huge megastore.





SPACEWALL®

44000

Order No.

44000-000-00

The SPACEWALL® shop-fitting system can be individually implemented in already existing shops or in complete new stores. You can choose for example from following surface finishes for your slatwall: unfinished or paint finished surface or a painted wall according to your desired RAL/NCS color. You also have the choice between a melamine resin coated surface in the colors white, grey, ivory or cream-white or a plastic-laminated slatwall in either white E110 MP or grey E 6 MP. Further possibilities are metallic or acrylic mirror designs or wood veneer finishes like pine, spruce, maple or alder. Further finish variations on request. We offer you the following slat widths: 53.1 mm, 76.3 mm, 88.0 mm*, 101.8 mm, 152.6 mm, 203.5 mm, 244.2 mm, 305.3 mm. Head pieces and bases can be produced on request. Ask for special design variations and other sizes for your slatwall!

* Size 2430 mm x 1210 mm or 1210 mm x 2430 mm.

PRODUCT SUPPORT ARM

441/1	
Weight	0.568 kg
Special features	suitable for heavy products
Material	steel
Support	felt pads
Angle of inclination	23°
Support depth	from 261 to 461 mm

Order No.
black 44110-000-55



PRODUCT HOLDER

44130	
Weight	0.179 kg
Material	steel
Suitable for	Euroslot hangers
Length	150 mm

Order No.
black 44130-000-55

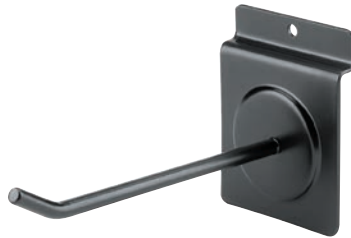

PRODUCT HOLDER

44135	
Weight	0.22 kg
Material	steel
Suitable for	Euroslot hangers
Length	280 mm

Order No.
black 44135-000-55



PRODUCT HOLDER FOR GUITAR

44140	
Weight	0.44 kg
Special features	patented flexible hooking-in and clamping system suitable for asymmetric guitar necks
Material	steel
Direction	forward-turned
Instrument support	non-marring plastic material
Yoke	self-locking
Suitable for	acoustic and electric guitars
Dimensions	95 x 130 x 158 mm

Order No.
black 44140-000-55



Patented flexible hooking-in and clamping system

PRODUCT HOLDER FOR GUITAR

44160	
Weight	0.3 kg
Material	steel
Direction	forward-turned
Instrument support	non-marring plastic material
Yoke	self-locking
Suitable for	acoustic and electric guitars
Dimensions	88 x 93 x 140 mm

Order No.
black with translucent support elements 44160-000-00
black 44160-000-55



PRODUCT HOLDER FOR GUITAR

44170	
Weight	0.48 kg
Material	steel
Direction	left or right turned
Instrument support	non-marring plastic material
Yoke	self-locking
Suitable for	acoustic and electric guitars

Order No.
black with translucent support elements 44170-000-00
black 44170-000-55



PRODUCT HOLDER FOR GUITAR

44180	
Weight	0.29 kg
Material	steel
Direction	right
Instrument support	non-marring plastic material
Yoke	fixed
Suitable for	acoustic and electric guitars
Dimensions	88 x 107 x 300 mm

Order No.
black 44180-000-55



PRODUCT HOLDER FOR GUITAR

44181	
Weight	0.29 kg
Material	steel
Direction	left
Instrument support	non-marring plastic material
Yoke	fixed
Suitable for	acoustic and electric guitars
Dimensions	88 x 107 x 300 mm

Order No.
black 44181-000-55



PRODUCT HOLDER FOR ACOUSTIC GUITAR

44185	
Weight	1.09 kg
Special features	flexible support arms for neck and body
Material	steel
Support	silicone cover
Direction	in 8° settings 360° adjustable
Suitable for	electric guitars
Dimensions	690 x 220 x 165 mm

Order No.
black 44185-000-55



PRODUCT HOLDER FOR ACOUSTIC GUITAR

44186	
Weight	1.15 kg
Special features	flexible support arms for neck and body
Material	steel
Support	silicone cover
Direction	in 8° settings 360° adjustable
Instrument support	non-marring rubber
Suitable for	acoustic guitars
Dimensions	690 x 220 x 215 mm

Order No.
black 44186-000-55



PRODUCT HOLDER FOR HEADPHONE

44195	
Weight	0.22 kg
Special features	for up to 2 standard headphones and 2 In-Ear headphones
Material	steel
Support	rubber covered
Support width	100 mm
Support depth	60 mm

Order No.
black 44195-000-55

Can easily take two sets of headphones



PRODUCT HOLDER FOR VIOLIN

44210	
Weight	0.15 kg
Special features	high quality flocking cover; with holder for bow plate
Material	plastic yoke, steel plate
Instrument support	flocked
Length	125 mm

Order No.
black 44210-000-55



PRODUCT HOLDER FOR SAXOPHONE

44240	
Weight	0.82 kg
Material	steel
Instrument support	non-marring plastic material

Order No.
black 44240-000-55



PRODUCT HOLDER FOR TROMBONE

44250	
Weight	0.58 kg
Special features	adjustable support cone
Material	steel
Instrument support	non-marring plastic material

Order No.
black 44250-000-55



PRODUCT HOLDER FOR TRUMPET

44270	
Weight	0.5 kg
Special features	rubber-covered peg top
Material	plastic peg, steel mounting bracket
Instrument support	felt pads

Order No.
black 44270-000-55



PRODUCT HOLDER FOR CLARINET

44280	
Weight	0.38 kg
Special features	with felt ring
Material	plastic peg, steel mounting bracket

Order No.
black 44280-000-55



PRODUCT HOLDER FOR FLUGEL HORN

44290	
Weight	0.59 kg
Material	plastic peg, steel mounting bracket
Instrument support	felt pads

Order No.
black 44290-000-55



PRODUCT HOLDER FOR SOPRANO-SAXOPHONE

44300	
Weight	0.5 kg
Material	plastic peg, steel mounting bracket
Instrument support	felt pads

Order No.
black 44300-000-55



PRODUCT HOLDER FOR FLUTE

44310

Weight	0.3 kg
Material	plastic peg with steel core, steel mounting bracket
Diameter	6.5 mm

Order No.

black 44310-000-55



PRODUCT HOLDER FOR FLUTE

44320

Weight	0.35 kg
Material	plastic peg with steel core, steel mounting bracket
Diameter	9.5 mm

Order No.

black 44320-000-55



PRODUCT HOLDER FOR FLUTE

44330

Weight	0.38 kg
Material	plastic peg, steel mounting bracket
Diameter	18 mm

Order No.

black 44330-000-55



PRODUCT HOLDER FOR CYMBAL

44380

Weight	0.36 kg
Material	steel
Diameter	10 mm
Length	300 mm

Order No.

black 44380-000-55



PRODUCT HOLDER FOR MICROPHONE

44500

Weight	0.31 kg
Special features	for microphones and other equipment with 3/8" threads
Material	steel
Length	140 mm
Threaded connector	3/8"

Order No.

black 44500-000-55



ADAPTER FOR PRODUCT HOLDER

44060

Weight	0.06 kg
Special features	it is easy to attach all SpaceWall® product support arms/holder to any regular wall (except for 44140, 44185 und 44186)
Material	plastic
Dimensions	101 x 84 x 18 mm

Order No.

black 44060-000-55



PRICE TAG HOLDER

44385

Weight	0.04 kg
Material	clear acrylic
Thickness	2 mm
Dimensions	100 x 55 mm

Order No.

44385-000-00



PRODUCT LABEL BUNDLE

77977

Special features	download of corresponding product specifications on our website; a set consisting of: 10 pieces plastic cover (transparent) and 2 meter elastic (black)
Material	plastic
Dimensions	180 x 115 mm

Order No.

77977-000-00



Download of corresponding product specifications on our website

LEAFLET HOLDER

44420

Weight	0.56 kg
Material	clear acrylic
Suitable for	A4 sheets
Thickness	4 mm
Dimensions	225 x 60 x 230 mm

Order No.

44420-000-00



19" Power box	155, 156	Drum stick holder	110
19" Rack shelf	153	Drummer's throne	103, 105
19"-Power box	155	Drummer's throne »Gomezz«	104
A-guitar stand	50	Drummer's throne »Nick«	103
A-guitar stand »Heli 2«	52	Drummer's throne »Grande«	102
A-guitar stand »Wave 10«	53	Drummer's throne »Piccolino«	102
Accordion stand	96	Drummer's throne »Picco«	102
Adapter	129, 133, 219	E+A guitar stand »Duet«	51
Adapter bracket 1	237	E-guitar stand	50
Adapter bracket 2	237	E-guitar stand »Heli 2«	53
Adapter bracket 3	237	E-guitar stand »Wave 20«	53
Adapter bracket 4	237	English horn peg	94
Adapter bracket 5	237	Equipment stand	130
Adapter bracket 6	237	Extender brackets 19"	152
Adapter for product holder	272	Extension rod	142, 219
Adapter for screens	264	File holder	45
Adapter for »Spider Pro«	141	Five e-guitar stand »Guardian 5«	57
Adapter for »Spider«	136	Five guitar stand »Guardian 5«	58
Adapter sleeve	229	Flange adapter	227
Adapter sleeve »Ring Lock«	229	Floor stand for spot lights	243
Advertising panel for orchestra music desks	45	Flugelhorn peg	94
Amp stand	149	Flugelhorn stand	92
Ashtray	46	Flute holder	82, 83
Backrest	111	Flute peg	95
Baritone saxophone stand	74	Flute stand	79, 80, 81, 82
Baritone stand	85	Foldable base	93
Base plate	226	Footrest	62, 63, 111
Bass clarinet stand	77	Four guitar stand »Roadie«	56
Bass drum stand	98	French horn stand	92
Bass trombone stand	83	Gooseneck	187, 188
Bassoon stand	75	Guitar capo	64, 65, 66
Bearing plate	218	Guitar holder	59
Boom arm	134, 180, 181	Guitar performer stand	58, 59
Bracket	93	Guitar playing-aid »Pohlmann«	66
Cable clamp	230	Guitar stand »Double«	55
Cable hanger	156	Guitar stand »Memphis 10«	54
Cable holder	230	Guitar stand »Memphis 20«	54
Carrier bag for round base	231	Guitar stand »Memphis Pro«	54
Carrying case	42, 44, 72, 76, 85, 111, 112, 113, 142, 143, 198, 199, 231	Guitar stand »Memphis Travel«	50
Carrying case	86, 230	Guitar tool	66
Carrying case »Pro«	231	Guitar wall mount	59, 60, 61
Ceiling stand	197	Hackbrett stand	68
Cello stand	71, 70	Harmonica holder	96, 97
Clarinet holder	78	Headphone holder	146, 156
Clarinet peg	94	Headphone holder with table clamp	146
Clarinet peg-set	92	Headphone wall holder	147
Clarinet stand	78, 79	Holder with tuning key	110
Connection sleeve	245	Inclinable stand adapter	229
Connector plate	226	Keyboard bench	113
Contrabassoon stand	75	Keyboard stand	122, 123, 124
Controller keyboard tray	139	Keyboard stand for kids	122
Counter weight	203	Keyboard stand »Baby-Spider Pro«	138
Crossbar	243	Keyboard stand »Rick 20«	126
Design microphone table stand	183	Keyboard stand »Rick«	125
Design monitor stand	218	Keyboard stand »Spider Pro«	137
Distance rod	219, 220, 221, 222	Keyboard stand »Spider«	136
Distance rod with hand crank	221	Knurled washer	203
Distance rod with hand crank and »Ring Lock«	222	LED piano lamp	32, 33
Distance rod with pneumatic spring	223	LED replacement bulb	43
Distance rod »Ring Lock«	223, 224, 225, 226	LED USB light »Mighty Bright«	42
Double bass stand	71	LED USB light »Mighty Bright«	42
Double music stand light	31	Laptop holder	129
Double rack rail	156	Laptop rest	140
Drink holder	46	Laptop stand	249, 250, 251
		Leaflet holder	273
		Lectern desk for the »Spider Pro«	140

Lectern »Ovation Pro«	248	Power magnet	46
Levelling adapter	229	Power unit	42
Lighting stand	239, 240, 241	Price tag holder	273
Lighting/Speaker stand	242	Product holder	269
Magnet	45	Product holder for acoustic guitar	270
Magnet holder	42	Product holder for clarinet	271
Microphone arm	195	Product holder for cymbal	272
Microphone bar	198	Product holder for flugel horn	271
Microphone clip	201, 202	Product holder for flute	272
Microphone desk arm	194	Product holder for guitar	269, 270
Microphone holder	195, 198	Product holder for headphone	270
Microphone holder for drums	195	Product holder for microphone	272
Microphone stand	160, 161, 163, 164, 167, 168, 169, 170, 171, 173, 176, 178	Product holder for saxophone	271
Microphone stand »Rien«	177	Product holder for soprano-saxophone	271
Microphone stand »Soft-Touch«	163, 171, 172, 179	Product holder for trombone	271
Microphone table base	185, 186	Product holder for trumpet	271
Microphone »Fishing Pole«	189, 190, 191	Product holder for violin	270
Mini boom arm	181	Product label bundle	273
Mixer stand	148, 150	Product support arm	269
Monitor stand	148, 217	Projector tray	217
Mounting adapter	227	Promotional board (excl. Logo)	248
Music holder	45, 68, 134	Protective cover for lectern	248
Music stand	16, 17, 18, 19, 20, 21	Quick-Release Adapter for microphones	204
Music stand light	31, 34, 36	Rack	152, 153
Music stand light package	36	Rack desk stand	151
Music stand light »Mighty Bright - Crescendo«	41	Rack wagon	151, 152
Music stand light »Mighty Bright - Double Flex«	37	Rackmount lockbox	154
Music stand light »Mighty Bright - Duet 2«	38	Rackmount storage	155
Music stand light »Mighty Bright - Encore Light«	40	Rackshelly	153
Music stand light »Mighty Bright - Hammer Head«	39	Reading light »Mighty Bright - Xtra Flex 2«	36
Music stand light »Mighty Bright - Orchestra Light«	39	Reducer flange	244, 245
Music stand light »Mighty Bright - Pedal Board Light«	39	Replacement bulb	43
Music stand light »Mighty Bright - Xtra Flex«	37	Safety ring	230
Music stand light »Twin Head«	35	Saxophone stand	72
Music stand »Robby Plus«	19	Saxophone stand »Jazz«	73
Mute holder	91	Saxophone stand »Saxxy«	73, 74
Mute holder ring	91	School orchestra music stand	21
Oboe peg	94	Screen/Monitor stand	252, 253
Oboe stand	79	Screw fitting set	244
One hand microphone stand	162, 163	Screw-on adapter	227
One-hand microphone stand »Elegance«	165	Seat cushion - imitation leather	117
One-hand microphone stand »Performance«	166	Seat cushion - leather	117
One-hand orchestra music stand	26	Seat cushion - velvet	116
Orchestra conductor stand	27	Sheet music and document holder	199
Orchestra music stand	21, 22, 23, 24, 25	Sheet music clip	46
Orchestra music stand »Symphony«	23	Sheet music holder	46
Overhead microphone stand	174, 175	Sheet music holder for »Spider Pro«	141
Pan pipe holder	83	Shoulder bag for sheet music and tablets	265
Panel	154	Side cover	151
Peg adapter	95	Side crossbar	243
Peg holder	95	Single rack rail	156
Pencil holder	47	Sliding shelf	153
Piano bench	114	Smartphone holder	260
Piano bench - wooden-frame	115	Smartphone stand	254
Piano bench with quilted seat cushion	118	Soprano saxophone peg	94
Piano bench with sheet music storage	117	Soprano saxophone stand	72, 74
Piano bench »Uplift«	114	Sound insulation stand	28
Piano stool	119	Sousaphone stand	88
Piano tuning lever	99	SpaceWall®	268
Piano tuning lever set	99	Speaker ceiling mount	236
Pick holder	203	Speaker mount	228
Plexiglass security cover	157	Speaker mounting fork	230
Pneumatic stool	107	Speaker stand	208, 209, 210, 211, 212, 213, 214
Popkiller	192, 193	Speaker stand package	208, 209
		Speaker stand with pneumatic spring	214

Speaker stand »Ring Lock«	215, 216	Violin holder	69
Speaker tilt connector	228	Violin stand	69, 70
Speaker tilt connector »Ring Lock«	228	Violin wall holder	69
Speaker wall mount	232, 233, 234, 235, 236, 238	Violin/Ukulele display stand	70
Speaker wall/ ceiling mount	235	Wall mount for acoustic guitar	62
Speaker/Monitor stand	208	Wall mount for electric guitar	62
Spike set	110	Warning strip	230
Stackable microphone stand	162	Wooden music stand	29
Stackable one-hand microphone stand	162	iPad Air 2 holder	261
Stacker	124, 129, 133	iPad Air 2 stand	254
Stacker A	130	iPad Air 2 stand holder	264
Stacker B	131	iPad Air 2 table stand	257
Stage stool	109	iPad Air 2 wall mount	259
Stand for electric double bass	71	iPad Air holder	261
Stand for kingsize tuba	86	iPad Air stand	253
Stool	106, 108	iPad Air stand holder	263
Support arm set	136	iPad Air table stand	256
Support arm set A	139	iPad Air wall mount	258
Support arm set B	139	iPad holder	260
Support bracket	156	iPad mini holder	260
TV pin	244	iPad mini stand holder	263
Table clamp	195, 196	iPad mini table stand	255
Table flange	194, 202	iPad mini wall mount	258
Table microphone clamp	195	iPad stand	253
Table microphone stand	182, 183, 184	iPad stand holder	263
Table music stand	30	iPad table stand	255
Table- /Floor microphone stand	184, 185	iPad wall mount	258
Table-style keyboard stand	130, 132		
Table-style keyboard stand »Omega«	128		
Table-style stage piano stand	133		
Tablet PC holder	262		
Tablet PC stand	254, 255		
Tablet PC stand holder	264		
Tabletop microphone stand	184		
Tenor horn stand	85		
Thread adapter	199, 200, 201, 203		
Threaded bolt	196		
Threaded bolt set for »Spider Pro«	141		
Three guitar stand »Guardian 3«	58		
Transportation case (hard case) for Lectern	249		
Tray	45		
Triangle holder	98		
Trombone stand	84		
Trumpet holder	90		
Trumpet peg	93		
Trumpet stand	88, 89, 90		
Trumpet work station	91		
Tuba performer stand	87		
Tuba performer stand for children	87		
Tuba stand	86		
Tuning fork	99		
Ukulele holder	67		
Ukulele wall mount	67		
Uni-Boy »Book« stand	30		
Uni-Boy »Classic« stand	30		
Universal carrying case	75		
Universal clamping holder	196		
Universal drink holder	46		
Universal holder	134, 147		
Universal holder for »Spider Pro«	140		
Universal joint	201		
Universal rack shelf	153		
Universal speaker wall mount	234		
Universal table-top stand	249		
Ventilation panel	154		

Sales only through specialist shops.

When ordering please regard package units. Specifications subject to change without notice. No guarantee undertaken for printing errors.
Reprints (or duplication) prohibited. All supplies and deliveries are subject to our terms and conditions of sale, delivery and payment.



KÖNIG & MEYER
Stands For Music

KÖNIG & MEYER GmbH & Co. KG
Postfach 1453 · 97864 Wertheim/Main · Germany
Kiesweg 2 · 97877 Wertheim/Main · Germany
Tel.: +49 (0) 93 42/806-0 · Fax: +49 (0) 93 42/806-150
e-Mail: contact@k-m.de · www.k-m.de